

Dimension Guide

Induction cooktop

Model:
EHI7280BB

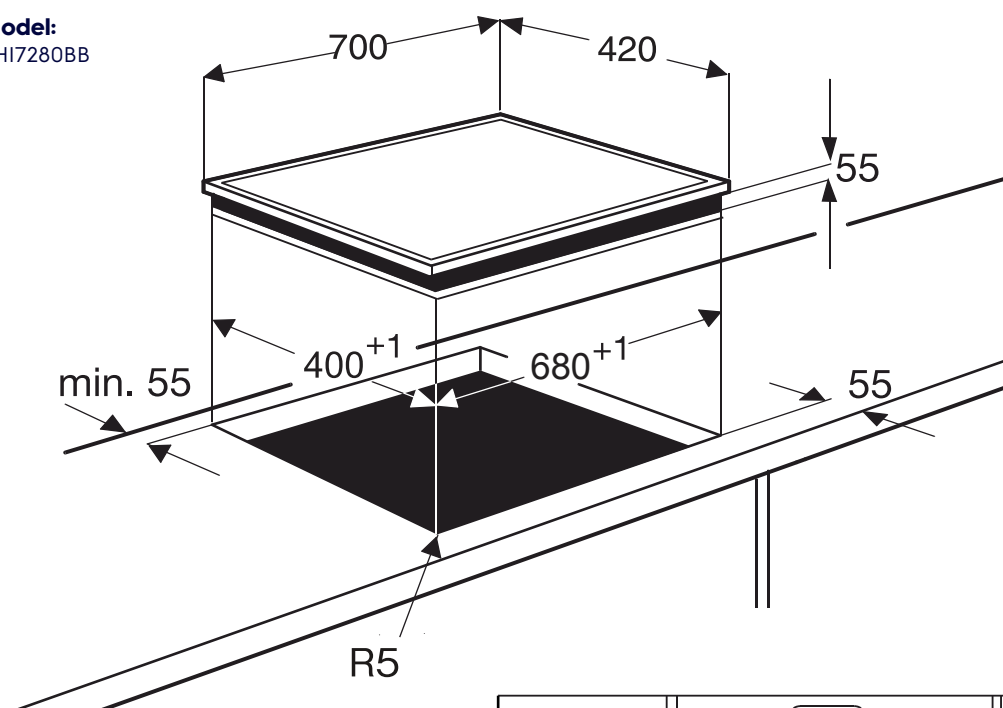

Note: The clearance must meet or exceed the minimum recommended for both the rangehood and cooktop. Refer to the rangehood installation manual

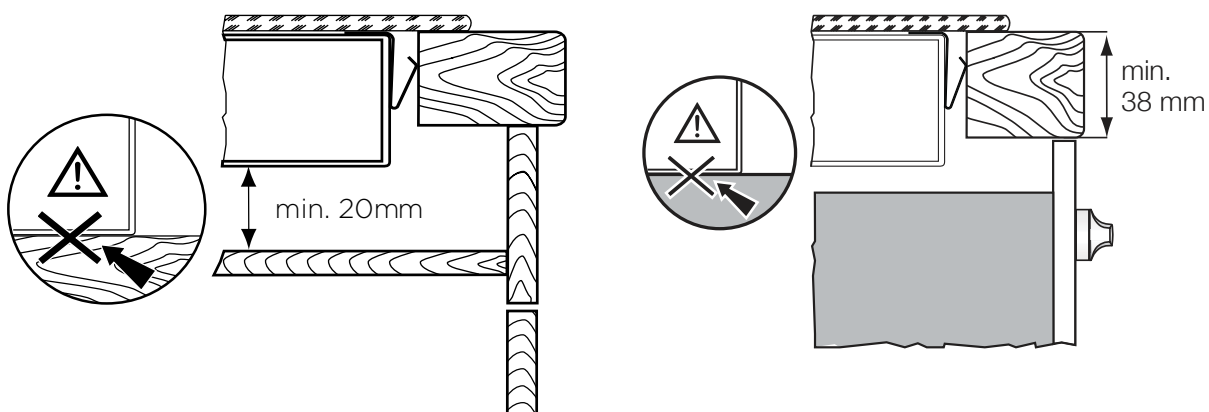
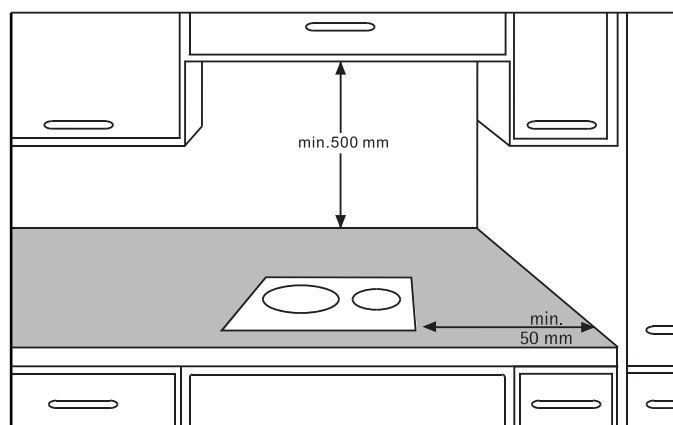

IMPORTANT

This is a guide of product dimensions only. For complete installation instructions, refer to the manual provided with product.

© 2021 Electrolux S.E.A PTE.LTD.. E_DIM_EHI7280BB_A4_Apr21