



Electrolux

Master 9 Multi-blender

E9TB1-90BP

E9TB1-90PP

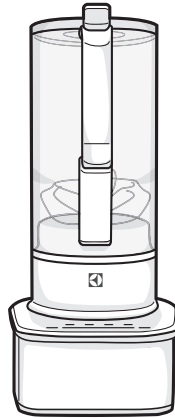

E9TB1-92BP

E9TB1-92PP

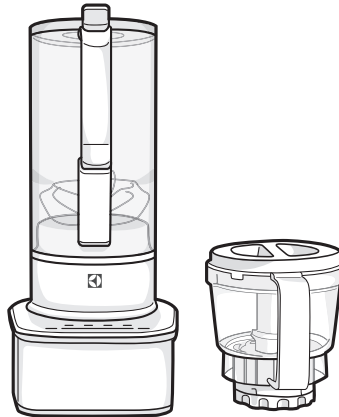

E9TB1-99PP

E9TB1-99BP

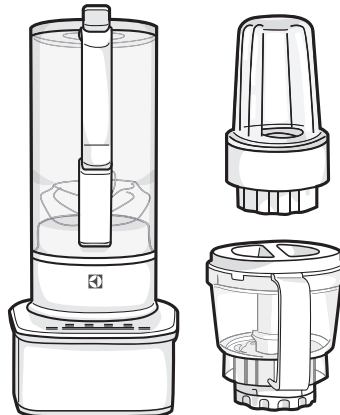



Overheat protection

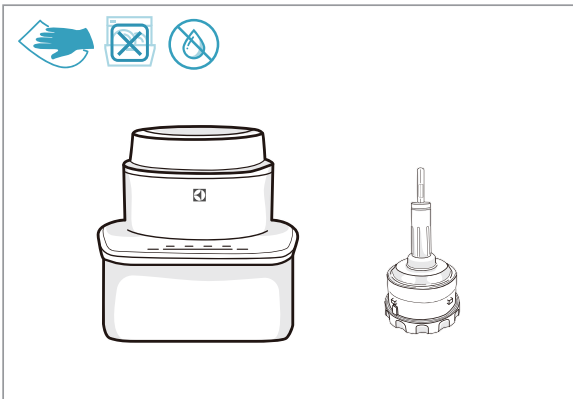
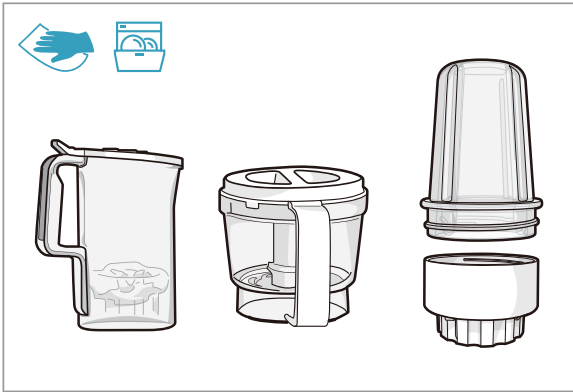
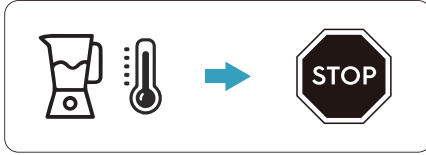

The software in this appliance is partly based on free and open source software.
To see the full copyright information and applicable license terms, please visit:
www.electrolux.com/appliance-supplementary

HOW TO USE



<p>What to use for</p> <ul style="list-style-type: none"> Smoothie Soup Juice 	<p>1</p>	<p>2</p>	<p>3</p>
<p>4</p>	<p>5</p>	<p>6</p>	<p>7</p>
<p>8</p>	<p>9</p>	<p>10</p>	<p>11</p>



<p>What to use for</p> <ul style="list-style-type: none"> Carrots Onions Sorbet Salsa Hummus Nut butter 	<p>1</p>	<p>2</p>	<p>3</p>
<p>4</p>	<p>5</p>	<p>6</p>	<p>7</p>
<p>8</p>	<p>9</p>	<p>10</p>	<p>11</p>



<p>What to use for</p> <ul style="list-style-type: none">CoffeeSpicesNuts	<p>1</p>	<p>2</p>	<p>3</p>
<p>4</p>	<p>5</p>	<p>6</p>	<p>7</p>
<p>8</p>	<p>9</p>	<p>10</p>	<p>11</p>

COMPONENTS

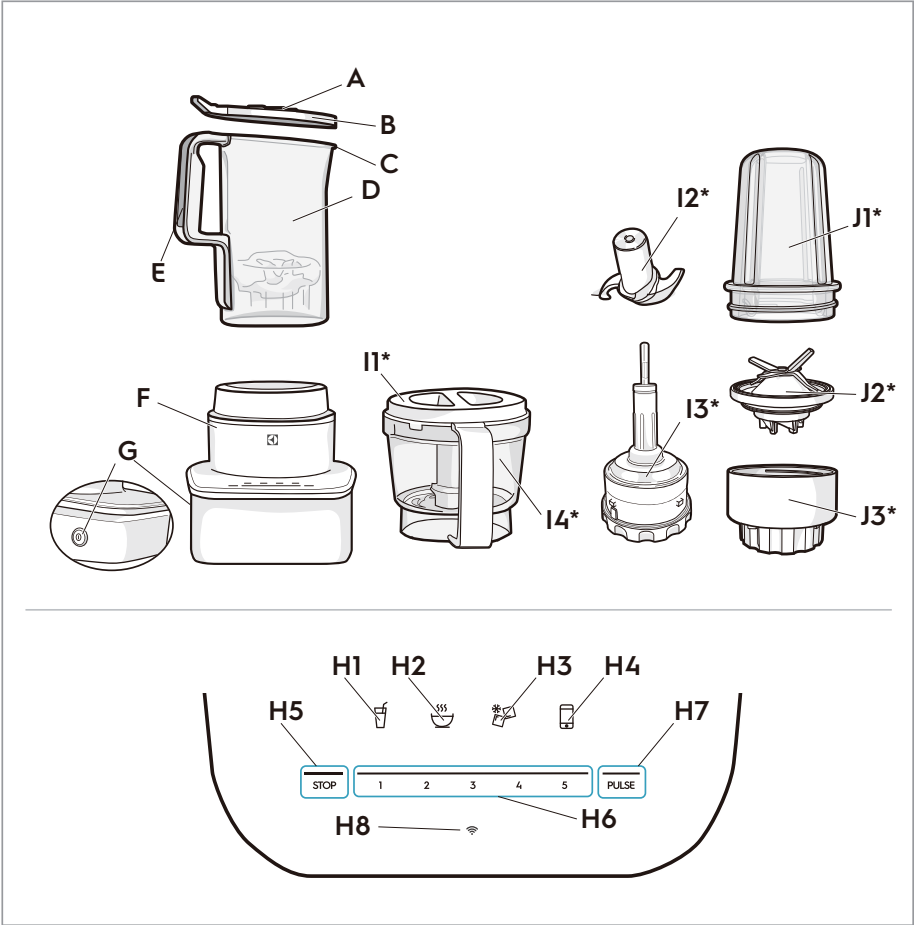

GETTING STARTED

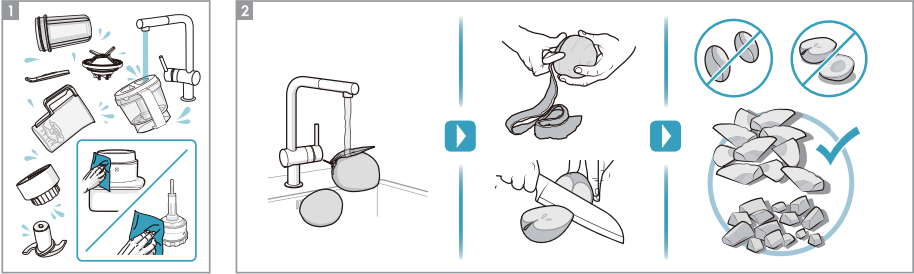

CONTENTS

ENGLISH	8	한국어	32
简体中文	16	bahasa Indonesia	38
繁體中文	24	ไทย	48
		Tiếng Việt	56

Thank you for purchasing an Electrolux appliance. You've chosen a product that brings with it decades of professional experience and innovation. Ingenious and stylish, it has been designed with you in mind. So whenever you use it, you can be assured that you will get great results every time.

In order to ensure the best results, always use original Electrolux accessories and spare parts. They have been designed especially for your product. This product is designed with the environment in mind. All plastic parts are marked for recycling purposes

Welcome to Electrolux.

感谢您购买伊莱克斯电器。您的选择独具慧眼，这是一款拥有数十年专业经验和创新的产品，设计巧妙又时尚，让您铭记在心。无论何时，敬请放心使用，每次都会获得绝佳的使用体验。为了确保最佳效果，一定要使用原装伊莱克斯配件和备件。这款产品专为您而设计。本产品在设计时考虑了环保因素，所有的塑料配件均标明了回收标记。

欢迎使用伊莱克斯电器。

感謝您購買伊萊克斯電器。您的選擇獨具慧眼，這是一款擁有數十年專業經驗和創新的產品，設計巧妙又時尚，讓您銘記在心。無論何時，敬請放心使用，每次都會獲得絕佳的使用體驗。為了確保最佳效果，請務必搭配依萊克斯原裝配件與零件使用。這款產品專為您而設計。本產品在設計時考慮了環保因素，所有的塑料配件均標明了回收標記。

歡迎使用伊萊克斯電器。

Electrolux 전자기기를 구입해 주셔서 감사합니다. 귀하께서는 저희 회사가 수십 년 동안 쌓아 올린 전문적인 경험과 혁신이 살아 있는 제품을 고르셨습니다. 이 제품은 독창적이고 세련되었을 뿐 아니라 사용자를 염두에 두고 설계되었습니다. 그러므로 언제 사용하시더라도 늘 좋은 결과를 얻을 수 있는 믿을 수 있는 제품입니다.

언제나 최고의 결과를 얻기 원하신다면 Electrolux 정품 부속품과 예비 부품만 사용하십시오. 구입하신 제품을 위하여 특별 제작된 것들입니다. 이 제품은 환경을 염두에 두고 설계되었습니다. 모든 플라스틱 부품들은 재활용 마크가 표시되어 있습니다.

Electrolux에 오신 것을 환영합니다.

Terima kasih telah membeli perabot dari Electrolux. Anda telah memilih produk yang menghadirkan pengalaman profesional dan inovasi selama beberapa deka-de. Produk yang canggih dan bergaya ini dirancang khusus untuk Anda, dan kami menjamin Anda akan mendapatkan hasil yang memuaskan.

Untuk memastikan hasil terbaik, selalu gunakanlah aksesoris dan suku cadang Electrolux asli yang telah dirancang khusus untuk produk Anda. Produk ini didesain dengan memperhatikan aspek lingkungan. Semua komponen plastik memiliki label khusus untuk daur ulang.

Selamat datang di Electrolux.

ขอบคุณที่เลือกซื้อผลิตภัณฑ์ของ Electrolux คุณได้เลือกผลิตภัณฑ์ที่มอบประสบการณ์และนวัตกรรมระดับมืออาชีพอย่างต่อเนื่องมาเป็นเวลาหลายสิบปี ผลิตภัณฑ์ของเราชาญฉลาดและดีไซน์สวยงาม และออกแบบโดยคำนึงถึงผู้ใช้งานเป็นสำคัญ ดังนั้น เมื่อไหร่ที่คุณใช้งานผลิตภัณฑ์ของเรา คุณจะวางใจได้ว่าผลลัพธ์ที่ออกมาจะดีเยี่ยมทุกครั้ง และเพื่อให้คุณได้รับผลลัพธ์ที่ดีที่สุด กรุณาใช้อุปกรณ์เสริมและอะไหล่ของแท้จาก Electrolux อะไหล่เหล่านี้ออกแบบมาเพื่อผลิตภัณฑ์ของคุณโดยเฉพาะผลิตภัณฑ์นี้ออกแบบโดยคำนึงถึงสิ่งแวดล้อม ชิ้นส่วนพลาสติกทั้งหมดมีเครื่องหมายกำกับเพื่อนำไปรีไซเคิล

ยินดีต้อนรับเข้าสู่โลกของ Electrolux

mang trong mình hàng thập kỷ trải nghiệm chuyên môn và cải tiến. Tinh xảo và phong cách, sản phẩm này được thiết kế dành cho quý vị. Vì vậy bất cứ khi nào quý vị sử dụng sản phẩm, quý vị có thể an tâm rằng mình sẽ nhận được kết quả tuyệt vời mỗi lần sử dụng. Để đảm bảo có được kết quả tốt nhất, hãy luôn luôn sử dụng các phụ kiện và phụ tùng chính hãng của Electrolux.

Các phụ kiện và phụ tùng được thiết kế dành riêng cho sản phẩm của quý vị. Sản phẩm này được thiết kế dành cho môi trường. Mọi bộ phận nhựa đều được đánh dấu với mục đích tái chế

Chào mừng đến với Electrolux

INSTRUCTION MANUAL

Graphics and drawings in this manual are solely for illustration purposes and are subject to variations from actual product.

Read all instructions carefully before using the appliance for the first time.

Keep this manual for future reference.

COMPONENTS

- | | |
|--|--|
| A. Measuring cup (dishwashable) | II. Chopper lid* (dishwashable) |
| B. Blender lid with filler hole (dishwashable) | II2. Chopper blades* (dishwashable) |
| C. Spout | II3. Chopper gearbox* |
| D. Blender jug with non-detachable blades (dishwashable) | II4. Chopper jug* (dishwashable) |
| E. Handle | JI. Grinder jar* (dishwashable) |
| F. Base Unit | JI2. Grinder blades* |
| G. On/off button | JI3. Grinder blade assembly holder* (dishwashable) |
| H1. Smoothie icon | |
| H2. Soup icon | *Certain models only |
| H3. Ice crush icon | |
| H4. Start recipe from App icon | Pictures on pages 3-5 |
| H5. Stop icon | |
| H6. Speed 1 – 5 icon | |
| H7. Pulse icon | |
| H8. Wifi connected icon | |

SAFETY ADVICE

- Remove and safely discard any packaging materials before using the appliance.
- This appliance is not intended for use by persons (including children) with reduced physical, sensory or mental capabilities, or lack of experience and knowledge, unless they have been given supervision or instruction concerning the use of the appliance by a person responsible for their safety.
- Keep the appliance and its power cord out of reach of children. Children should be supervised to ensure that they do not play with the appliance.
- Cleaning and maintenance should not be performed by children unless they are supervised.
- The appliance can only be connected to a power supply which voltage and frequency comply with the specifications on the rating plate.
- Never use or pick up the appliance if the power cord is damaged and/or the housing is damaged.
- If the appliance or its power cord is damaged, it must be replaced by Electrolux or its service agent in order to avoid hazard.
-  Do not immerse the appliance, its power cord or plug in water or any other liquid.
- Do not use or place the appliance near the edge of the table or counter, near hot gas, stove, electric burner or heated oven.
- Always place the appliance on a flat, level and dry surface.
- Always switch off the appliance and disconnect it from the power supply if it is left unattended and before changing of the accessories, cleaning or maintenance.
- The blades and inserts are very sharp. **Danger of injury.** Care shall be taken when changing accessories, after use and during cleaning and maintenance.
- Never touch the blades or inserts with your hand or with any utensils while the appliance is plugged in and/or during operation.
- Do not attempt to remove the blade assembly.
- Keep hands and utensils away from the appliance during operation to avoid the risk of severe injury to persons or damage to the appliance.
- Ensure that the appliance is switched off before removing the carafe from the motor base.
- Do not operate the appliance without food or liquid in the carafe.

- Never operate the appliance without the lid.
- Do not use the appliance continuously for more than 3 minutes when processing heavy load. After using for 3 minutes with heavy loads, the appliance should be left to cool for at least 20 minutes before restarting.
- The appliance cannot be used for blending or grinding hard and dry substances, except for ice cubes.
- Be careful if hot liquid is poured into the appliance as it can be ejected out of the appliance due to a sudden steaming.
- Never process boiling liquids (max 90°C).
- Do not exceed the maximum filling volume as indicated on the appliance.
- Do not use this appliance to stir paint. Danger, could result in an explosion!
- Do not let the power cord come into contact with hot surfaces or hang over the edge of a table or counter.
- Never use accessories or parts made by other manufacturers not recommended or sold by Electrolux as it may cause a risk of injury to persons.
- This appliance is for indoor use only.
- This appliance is intended for domestic use only. Electrolux will not accept any liability for possible damage caused by improper or incorrect use.
- This appliance is suitable to operate on both 50 and 60Hz.
- CAUTION: In order to avoid a hazard due to inadvertent resetting of the thermal cut-out, this appliance must not be supplied through an external switching device, such as a timer, or connected to a circuit that is regularly switched on and off by the utility.

GETTING STARTED

Before using your appliance for the first time, remove all packing material such as plastics, stickers or tags that may be attached to the components. Clean the appliance and accessories, see instructions: "Cleaning and Care".

Always prepare the ingredients: Rinse them thoroughly and cut them into 4 to 6 pieces and remove any hard or large seeds. Remove any thick peel from the fruit or vegetables.

USING THE PRODUCT

1 Cleaning - Make sure that you start with a clean jug/jar, rinse the jug/jar before use.

2 Plug into mains

3 Maximum load

Blender - You can blend maximum 1.5L of ingredients with the blender, in order to avoid splashing out ingredients. **WARNING!** We recommend to allow hot liquids to cool down (max 90 °C) before filling the jug. Fill the jar only half full and start blending on low speed.

The blender jug can become very warm, operate with caution to protect your hands and to ventilate steam out through the filler hole.

Chopper - You can chop maximum 0.4L of ingredients with the chopper, in order to avoid splashing out ingredients.

Grinder - You can grind maximum 0.25L of ingredients with the grinder, in order to avoid splashing out ingredients.

4 Jug/jar assembly

Blender - Blender - Place the lid on the jug, make sure that the lid is tightly fitted. Fit the measuring cup in the lid by rotating clockwise until it clicks into position. You can add ingredients through the filler hole newly added text translation required.

Chopper - Push the chopper gearbox into the chopper jug from the bottom and rotate it clockwise until it clicks into position. Place the chopper blades on the tower in the chopper jug, and push down the blades into position. Place the chopper lid on the jug and turn clockwise until it clicks into position.

Grinde - Place the grinder jar with the open end up, and fill in the ingredients. Push the grinder blade facing upwards in the grinder blade assembly holder until it is firmly sitting in its place. Turn the blade assembly holder upside down, and screw it on the jar until tightly sealed. Turn the unit with the ingredients upside down.

- 5 Placing the jug/jar on base unit**
Blender and chopper -Place the jug on the base unit with the handle to the right. Rotate it clockwise until it locks into position. (The jug can only be placed in one position, the handle facing you). Place the ingredients in the jar.
Grinder - Hold the grinder blade assembly holder and place the assembled grinder on the base unit. Rotate it clockwise until it locks into position.
 The jar can only be placed in one position, make sure the locking symbol on the blade assembly holder is facing you when positioning the jar.
- 6 Start the blender** - Press the On/off button. The icons will light up illuminating the display.
- 7 Choosing the right speed or program**
 You have preset speeds 1-5, dedicated recipe programs- smoothie, Soup, Ice crush, and Pulse mode to choose from. The selected speed or recipe program will light up. You can activate any speed by tapping on the speed setting and adjust the speed either by tapping a different speed, or sliding your fingers on the speed bar. With Pulse mode you can give the ingredients a quick mix to achieve your desired consistency. Press the Pulse icon to go into Pulse mode. The Pulse and the speed icons start blinking. Press 1 to 5 to pulse at different speeds. Press the Start recipe from App icon if you would like to perform the program received from the app.
Recommended settings/ programs for the blender - Smoothie, Soup, Ice crush, Speeds (1-5), Pulse mode
Recommended settings/ programs for the chopper and grinder- Speeds (1-5), Pulse mode
IMPORTANT! Your blender is equipped with a dual safety system. The product will not start operating and the display will flash indicating that either the lid or the jug/jar is not placed into position. This ensures that you don't run into nasty accidents in your kitchen.
WARNING! Never remove the measuring cup or the lid while running the product. Never run the blender empty, running the blender empty can cause overheating and can damage the product. Keep hands and utensils out of the blender jar while blending.
- 8 Stopping the product** - The blender will operate until the program is finished. To stop any program manually, press the Stop icon.
- 9 Cleaning after use** - We recommend that you wash the components right after use in order to avoid drying of food residue on components.
IMPORTANT! To avoid crazing of the jug/jar, always rinse the jug/jar with clean water directly after use in order to prevent acids or essential oils decolouring the plastic material. Always rinse the jug/jar clean even before placing it into the dishwasher. Fill the jug/jar with luke warm water, close the lid and place the jug/jar on the base unit.
- 10 Cleaning speeds** -Run speed 5 for 30 seconds on the blender and the grinder, run on speed 1 for the chopper.
- 11 Unplug the appliance**

CLEANING AND CARE

Thorough cleaning of the base unit and the interface -Turn the blender off and unplug the power cord. Wipe the blender base with a damp cloth.

WARNING! Never immerse the base unit, plug, or cord in water or any other fluid.

Thorough cleaning of the jug/jar -Remove all components. Rinse the blades in water and detergent. Note! The blender blade is not removable.

WARNING! Handle carefully, the blades are very sharp!

Enjoy your new Electrolux product!

DISPOSAL



This symbol on the product or on its packaging indicates that the product may not be treated as household waste. To recycle your product, please take it to an official collection point or to an Electrolux service center that can remove and recycle the battery and electric parts in a safe and professional way. Follow your country's rules for the separate collection of electrical products and rechargeable batteries.

Electrolux reserves the right to change products, information and specifications without notice.

CUSTOMER CARE AND SERVICE

When contacting Service, ensure that you have the following data available: **Model, PNC, Serial Number**. The information can be found on the rating plate.





Due to the Electrolux policy of continual product development; specifications, colours, and details of our products and those mentioned in this manual are subject to change without notice.

RECIPES

Make sure that your appliance are connected to Master X App so that you can get the most out of your blender. There are >25 Quick Recipe Programs &>15 Step-by-Step Recipes that can inspire your daily cooking.

Below table shows Master 9 Blender Recipe general guidance.

MAXIMUM PROCESSING TIME WITH HEAVY LOAD	MAXIMUM VOLUME
2 min	1500 ml

RECOMMENDED BLENDING SPEED					
Recipe	Ingredients	Quantity		Time	Speed setting
Pureeing raw vegetables	Carrots	20-160	g	30 s	5 (Max speed)
	Potatoes	20-160	g		
	Onions	20-160	g		
	Water	40-320	g		
Pineapple-apricots Smoothie	Pineapple in slices	250	g	≤ 120 s	
	Dried Apricots	40	g		
	Yoghurt	300	g		
Soup	Carrots	600	g	≤ 60 s	5 (Max speed)
	Water	900	ml		
Raspberries Smoothie	Frozen raspberries	250	g	≤ 60 s	
	Banana (½ pcs)	50	g		
	Water	50	g		
	Yoghurt	300	g		
Milkshake	Milk	150-300	ml	15-30s	
	Vanilla Ice cream	150-300	ml		
	Banana	¼ - ½	pcs		
	Chocolate syrup	30-60	g		
Potato leek soup	Potatoes	200	g	60s	
	Leek	200	g		
	Water	600	g		
Pancake (Batters)	Wheat flour	150	g	30-40s	
	Salt	1	pinch		
	Eggs	3	pcs		
	Milk	250	ml		
	Water	140	ml		
	Butter	50	g		

TROUBLESHOOTING

ITEM	SYMPTOM	CAUSE	SOLUTION	INDICATION
1	The blender does not start	The ON/OFF button was not pressed	Make sure the UI is in ON_IDLE mode. If not, press the On/off button to turn the blender on	No LEDs indicators are on
		a. Jug is incorrectly mounted or not locked in place before starting a program, pulse or speed selection b. Jug is incorrectly mounted or not locked in place after program was paused.	Mount and lock the jug correctly a. Start chosen program/speed again by pressing the corresponding button. b. Press blinking button to continue with paused program	a. All LEDs (except Wi-Fi) start pulsing for 3 seconds and then goes to ON_IDLE
		a. Lid is not placed or positioned correctly on jug before starting a program, pulse or speed selection b. Lid is not placed or positioned correctly on jug after program was paused.	Place or move lid to the correct position a. Start chosen program/speed again by pressing the corresponding icon. b. Press blinking button to continue with paused program	b. All LEDs (except Wi-Fi) start pulsing for 3 seconds and then goes back to the PAUSED state.
		The motor has overheated	Turn off the blender, unplug the machine, wait for 10 mins for the motor to cool down before turning on blender again	The appliance turns off and no LEDs indicators are on
		The plug is not properly connected to the power outlet or there is no power from the power outlet	Check the connection of the plug to the power outlet or try another outlet	No LEDs indicators are on
		Power outage	Wait until power outage is over to use product	No LEDs indicators are on
		In the APP_Mode, the blender cannot be started	The blender is disconnected from the network. Make sure the wireless network is working with Blender	APP cannot detect appliance
		Functional failure	Please contact local service support for further assistance	Appliance cannot function after troubleshooting measures are taken.

ITEM	SYMPTOM	CAUSE	SOLUTION	INDICATION
2	The motor stalls during operation	The jug or lid is removed during operation.	The jug and lid should be always mounted during operation Mount and place jug and lid correctly on appliance to continue usage	The motor stops running a. All LEDs start pulsing for 3 seconds and then goes to ON_IDLE. B. The UI continues to be in PAUSED state
		Overheat protection	If the motor stalls, turn off the blender immediately, unplug the appliance and let it cool for at least 10 minutes before plugging back and turning on.	The appliance turns off and no LEDs indicators are on
		Ingredients are too large.	Cut all ingredients into smaller pieces Unplug for 10 seconds and plug the machine to continue use the machine	The appliance turns off and no LEDs indicators are on
		Incorrect use of jug/accessories or Ingredients	Usage of jug and accessories should match with correct ingredients. (Jug is used for blending fruits and vegetables)	The appliance turns off and no LEDs indicators are on
		Stop timer is activated to prevent overheat	Press desired icons to continue usage	Appliance runs on one speed, pulse or program continuously for 3 minutes and stops All LEDs (except Wi-Fi) start pulsing for 3 seconds and then goes to ON_IDLE
3	Grinder jar leakage	Removing grinder from appliance by turning glass Jar instead of the blade assembly holder anti-clockwise may loosen glass jar and cause content to leak out.	Turn glass jar clockwise till tight on the blade assembly holder before mounting on appliance Turn ONLY the blade assembly holder anti-clockwise to unmount from appliance Do not turn glass jar to unmount	Content leaking out of glass jar when unmounting from appliance

ITEM	SYMPTOM	CAUSE	SOLUTION	INDICATION
4	Chopper does not function when mounted	Chopper gearbox is not assembled with chopper	Assembly chopper gearbox first, followed by chopper blade	When any icon is pressed, All LEDs are blinking for 3 seconds and chopper does not start
5	App account registration and login	Cannot create account	Email address has been used to create an account previously. Please use different email address to create a new account or continue on with email to assists on password reset for existing account	You receive the following message when registering for a new account "We've sent you an email so you can reset your password"
		a. Password error b. Account does not exist	a. Click on "forgot password" to receive an email to assists on password reset b. Click on "no account?" to create a new account	You receive the following message when attempting to login "invalid username or password"
6	Onboarding appliance	Appliance unable to connect to desired SSID WIFI	Renter WIFI password Setup router to allow Appliance to connect via WIFI (Please refer to your router manufacturer for setup assistance)	Setup failed
		Appliance unable to detect SSID	Router WIFI must broadcast 2.4 GHZ network SSID SSID setting in router cannot be hidden (Please refer to your router manufacturer for setup assistance)	Router SSID not visible in App during onboarding
		During process of connecting to appliance, WIFI icon on phone keeps blinking and setup fails after connection attempt	Please enable your phone's GPS and try connecting to appliance during onboard again	Phone GPS needs to be enabled to detect appliance APP. This is only needed for onboarding

ITEM	SYMPTOM	CAUSE	SOLUTION	INDICATION
7	Error in mobile phone application	Appliance is not connected to WIFI	Refer to your router manual for optimal performance distance and possible obstacle interference. Place blender as close as possible to router to prevent WIFI signal lost	WIFI icon is is off and not connected to WIFI network
		Appliance is not switched on	Press the On/off button at the side of Appliance Wait for WIFI icon to light up before sending setting from mobile application	Error in mobile phone application when sending setting to appliance

说明书

手册内的插图仅做说明使用，可能与实际产品不同。

首次使用本产品前，请仔细阅读下列说明。保留此说明书以便将来参考。

组件

- | | |
|--------------------------|-----------------------|
| A. 量杯（可用洗碗机清洗） | 11. 切碎杯盖*（可用洗碗机清洗） |
| B. 带有填料孔的搅拌罐盖子（可用洗碗机清洗） | 12. 切碎机刀片*（可用洗碗机清洗） |
| C. 壶嘴 | 13. 切碎杯变速箱* |
| D. 带有不可拆卸刀片的搅拌罐（可用洗碗机清洗） | 14. 切碎杯*（可用洗碗机清洗） |
| E. 手柄 | J1. 研磨罐*（可用洗碗机清洗） |
| F. 底座 | J2. 研磨机刀片 |
| G. 开/关按钮 | J3. 研磨机刀片支架*（可用洗碗机清洗） |
| H1. 制作奶昔程序图标 | |
| H2. 制汤程序图标 | *仅为某些型号提供 |
| H3. 冰沙程序图标 | 图 3-5 页 |
| H4. 应用程序初始食谱图标 | |
| H5. 停止程序图标 | |
| H6. 速度 1 - 5 图标 | |
| H7. 脉冲程序图标 | |
| H8. Wi-Fi 连接图标 | |

安全建议

- 使用本产品前请去除并扔掉所有包装材料。
- 本产品不可由肢体伤残、感觉或精神障碍以及缺乏相关经验和知识的人员（包括儿童）使用，除非有负责其安全的人员对其进行看管或指导。
- 将本产品及其电源线放在儿童够不到的地方。应对儿童加以看管，确保他们不将本产品作为玩具。
- 儿童不应在没有监管的情况下清洁和维护本产品。
- 本产品只能连接电压和频率均符合铭牌上规定的电源。
- 如果电源线损坏且/或防护外壳损坏，则不要再使用或收拾整理本产品。
- 如果本产品或电源线受损，必须由伊莱克斯或维修代理进行更换，以免发生危险。
-  不得将本产品、电源线或插头浸入水中或任何液体中。
- 不可在桌子或操作台的边缘，也不要再在热气体、火炉、电炉或加热的烤炉附近使用或放置本产品。
- 务必将本产品放置在一个平坦、水平且干燥的台面上。
- 本产品在无人看管时，或在更换附件、清洁及维护前，务必关闭本产品开关并断开其电源。
- 刀片和衬垫非常锋利。有受伤的危险。在更换配件、使用后以及清洗和保养时，应格外小心。
- 本产品接通电源时且/或运转期间，请不要用双手或任何器皿接触刀片或衬垫。
- 不要试图拆掉刀片组件。
- 电器运转时请保持双手和器皿远离，避免人员受伤或电器损坏。
- 从电机机座上拿掉搅拌杯时，请确保电器已经关断电源。
- 搅拌罐内没有食物或液体时，请不要操作本产品。
- 盖子没有盖好时，请不要操作本产品。

- 在处理大量食材时不要连续使用本产品超过2分钟。在连续2分钟处理大量食材后，应当让产品冷却至少5分钟才能再次使用。
- 除冰块以外，搅拌杯不得用于搅拌或研磨坚硬和干燥的物体。请使用多功能切菜杯研磨坚硬和干燥物体（例如坚果、糖果、糙米等）。
- 如果高温液体大量流入本产品时一定要小心，瞬间冒出的热气会让高温液体从产品溅出。
- 对于正在沸腾的液体，请勿使用（最高不超过90°C）。
- 不要超过本产品标明的最大装填量。
- 不要使用本产品搅拌油漆。这很危险，会导致爆炸！
- 不得让电源线接触到高温表面，或悬挂在桌子或操作台边缘。
- 请勿使用伊莱克斯不推荐的其他制造商制造的附件或部件，或并非由伊莱克斯出售的附件或部件，这可能会导致人员受伤。
- 本产品仅供室内使用。
- 本产品仅供家庭使用。伊莱克斯对因不适当或不正确使用本产品所可能导致的损害不负任何责任。
- 本产品适用于50及60Hz的电源频率下使用。
- 警告：为防止因意外复位热熔断路器造成的危险，本产品不得通过外部开关装置控制，例如计时器，或连接到由公共设施定期打开和关闭的线路。

开始使用

首次使用本产品前，请拆除所有可能附着在配件上的包装材料，如塑料、贴纸和标签。首次使用前，请清洗设备及配件。有关清洗说明，请参考“清洁与保养”部分。

准备好食材：彻底冲洗干净，切成4至6片，去掉任何坚硬或较大的种子。去掉水果或蔬菜的厚皮。

产品使用

1 清洁 - 确保使用干净的罐子，使用前冲洗罐子。

2 插入电源

3 最大负载

搅拌机 - 最多可以用搅拌机搅拌1.5升的食材，以避免食材溅出。**警告!** 建议等热的液体冷却后（最高90度）再倒入搅拌罐。将罐装满一半后开始低速搅拌。搅拌罐会变得非常热，小心操作，注意保护您的手，并通过填充孔将蒸汽排出。

切碎杯 - 切碎杯最多可以切碎0.4升的食材，以避免食材溅出。

研磨罐 - 您可以使用切碎杯研磨最多0.4升的食材，以避免食材溅出。

4 罐体组装

搅拌机 - 将盖子盖在罐子上，确保盖子紧密贴合。将量杯顺时针旋转安装在盖子上，直至其卡入到位。在搅拌机没有运转的情况下，您可以通过填料孔添加食材。

切碎杯 - 将切碎杯变速箱从底部推入切碎杯，顺时针旋转，直至其卡入到位。将切碎刀片放置在切碎杯中的轴上，然后将刀片向下推到正确位置。盖上切碎杯盖子，顺时针旋转直至其卡入到位。

研磨罐 - 将研磨罐开口向上放置，放入食材。将研磨机刀片朝上推入研磨机刀片支架，直至其牢固就位。将刀片支架倒置，将其拧在罐子上直至密封。将研磨罐倒置，翻转食材。

5 将罐子放在底座上

搅拌机 and 切碎杯 - 将罐子放在底座上，把手位于右侧。顺时针旋转直至其锁定到位。（罐子只能放在一个位置，把手面向您）。将食材放入罐子。

研磨罐 - 握住研磨罐的刀片支架，将组装好的研磨罐放在底座上。顺时针旋转直至其锁定到位。罐子只能放在一个位置，放入罐子时，请确保刀片支架上的锁定符号面向您。

6 开始使用搅拌机 - 按下开/关按钮。各图标会亮起，照亮显示屏。**7 选择正确的速度或程序**

有预设速度 1-5，专用配方程序- 奶昔、汤、冰沙及脉冲模式供您选择。选定的速度或食谱程序将会被点亮。您可以点击速度设置来激活任何速度，并通过点击不同的速度，或在速度条上滑动手指来调整速度。使用脉冲模式可以迅速的将食材混合，达到您所需的混合度。按下脉冲图标进入脉冲模式。脉冲及速度图标开始闪烁。按下1-5以不同的速度脉冲。如需使用来自App的程序，请按“开始应用程序配方”图标。

搅拌机的推荐设置/程序 - 奶昔、汤、冰沙，速度（1-5），脉冲模式

切碎杯和研磨罐的推荐设置和程序 - 速度（1-5），脉冲模式

重要! 搅拌机配有双重安全系统。产品无法启动，显示屏闪烁，表明盖子或罐子没有放置到位。这会确保您不会在厨房里发生严重事故。

警告! 产品运行期间切勿取掉量杯或盖子。切勿让搅拌机空转，搅拌机空转会致产品过热，损坏产品。搅拌期间确保手和餐具不要放置在搅拌机罐里。

8 停止使用 - 搅拌机将一直运行，直到程序完成。要手动停止任何程序请按停止图标。**9 用后清洁** - 建议您在用完之后立即清理，以避免食物残渣干燥后留在组件里。

重要! 为了避免罐子出现细纹，请在每次使用之后用清水冲洗干净，以防止食物中的酸性物质或挥发油使塑料材料脱色。在放入洗碗机前，请务必用清水彻底冲洗。在罐子中注满温水，盖好盖子，将罐子放在底座上。

10 清洁速度 - 清洁搅拌机和研磨罐时，以速度5运行30秒；清洁切碎机时，以速度1运行。**11 拔掉设备的电源插头。**

清洗及保养

彻底清洁底座和接口 - 关闭搅拌机，拔掉电源线。用湿布擦拭搅拌机底座。

警告! 切勿将底座、电源插头或电源线浸泡在水中或其他液体中。

彻底清洁罐子 - 拆除所有组件。用水和洗涤剂冲洗刀片。注意！搅拌机刀片不可拆卸。

警告! 小心处理，刀片非常锋利！

享用您的新伊莱克斯产品!

弃置



本产品或其包装上的这个标志说明该产品不可作为家庭垃圾丢弃。回收时，请携带该产品前往官方收集点或伊莱克斯（Electrolux）服务中心，以便以安全和专业的方式拆除并回收电池和电气部件。遵守您所在国家关于单独回收电气产品和充电电池的规定。

伊莱克斯（Electrolux）保留更改产品、信息和规格的权利，恕不另行通知。

客户服务

联系客服部门时，请确保您已掌握了以下信息：**型号、PNC、序列号**。此类信息可在铭牌上找到。

由于Electrolux坚持持续开发产品的政策，本手册之中提及的产品规格、颜色、详细信息等等均可能随时更改，恕不另行通知。

食谱

请确保将您的产品与Master X 应用程序链接，以便您可以充分利用搅拌机。共有超过25种快速食谱程序，及超过15种逐步食谱程序，将为您的日常烹饪带来快乐。

下表列出了Master 9搅拌机食谱的一般指南。

最长加工时间	最大容量
2分钟	1500毫升

推荐的搅拌速度

食谱	配料	数量		时间	速度设置
生蔬菜菜泥	胡萝卜	20-160	克	30 秒	5 (最大速度)
	土豆	20-160	克		
	洋葱	20-160	克		
	水	40-320	克		
菠萝杏干冰沙	菠萝切片	250	克	≤ 120 秒	
	杏干	40	克		
	酸奶	300	克		
汤粥	胡萝卜	600	克	≤ 60 秒	5 (最大速度)
	水	900	毫升		
树莓冰沙	冷冻树莓	250	克	≤ 60 秒	
	香蕉 (½根)	50	克		
	水	50	克		
	酸奶	300	克		
奶昔	牛奶	150-300	毫升	15-30秒	
	香草冰淇淋	150-300	毫升		
	香蕉	¼ - ½	颗		
	巧克力糖浆	30-60	克		
土豆浓汤	土豆	200	克	60 秒	
	大葱	200	克		
	水	600	克		
薄饼 (面糊)	小麦粉	150	克	30-40秒	
	盐	1	少许		
	鸡蛋	3	颗		
	牛奶	250	毫升		
	水	140	毫升		
	黄油	50	克		

故障排除

项目	故障	原因	解决方案	表现
1	搅拌机不能启动	没有按开/关按钮	确保UI处于ON_IDLE模式。 如果没有，按下开关按钮， 打开搅拌机。	LED指示灯没有亮起
		a. 在开始选择程序、 脉冲或速度之前，罐子 未正确安装或未锁定 到位。 b. 在程序暂停之后，罐 子未正确安装或未锁定 到位。	正确安装并锁定罐子。 a. 按下相应的按钮，再次启 动选定的程序/速度。 b. 按下闪烁按钮，继续暂停 的程序。	a. 所有LED显示灯 (Wi-Fi除外)开始 脉冲3秒钟，之后 进入ON_IDLE模式。
		a. 在开始选择程序、脉 冲或速度之前，盖子未 盖好或未放置到位。 b. 在程序暂停之后， 盖子未盖好或未放置 到位。	将盖子放置或移动到正确 的位置。 a. 按下相应的按钮，再次启 动选定的程序/速度。 b. 按下闪烁按钮，继续暂停 的程序。	b. 所有LED显示灯 (Wi-Fi除外)开始 脉冲3秒钟，之后 回到暂停状态。
		电机过热	关掉搅拌机，拔掉机器电 源插头，等待10分钟，让 电机冷却，然后再次开启 搅拌机。	设备关闭，没有LED显 示灯亮起
		插头未正确连接在电 源插座上，或电源插 座无电	检查插头与电源插座的连 接，或尝试其他插座	没有LED显示灯亮起
		断电	待供电后再使用本产品	没有LED显示灯亮起
		在应用程序模式下，搅 拌机无法启动	搅拌机与网络连接断开。 确保搅拌机无线网络工作 正常。	应用程序无法检测到 设备。
		功能故障	请与当地服务支持部门联系 以获得进一步帮助。	采取故障排除措施后， 设备仍不能正常工作。

项目	故障	原因	解决方案	表现
2	运行期间电机 停转	操作过程中，罐子或盖子被取掉	操作过程中，罐子或盖子应始终安装好 将罐子和盖子正确安装或放置在设备上以便继续使用	电机停止运行 A. 所有LED显示灯开始脉冲3秒钟，之后进入ON_IDLE模式。 B. UI继续处于暂停状态。
		过热保护	如果电机停转，立刻关闭搅拌机，拔掉设备电源插头，让设备冷却至少10分钟，之后再重新接通电源，打开设备。	设备关闭，没有LED灯亮起。
		食材尺寸过大	将所有食材切成小块 拔下插头10秒钟，之后插上机器插头继续使用	设备关闭，没有LED灯亮起。
		罐子/配件或食材使用不当	罐子或配件的使用应与正确的食材相匹配（罐子用于搅拌水果和蔬菜）。	设备关闭，没有LED灯亮起。
		停止计时器被激活，防止过热	按下所需的按钮继续使用	设备以一个速度、脉冲或程序连续运行3分钟后停止。 所有LED显示灯（Wi-Fi除外）开始脉冲3秒钟，之后进入ON_IDLE模式
3	研磨罐泄露	通过逆时针旋转玻璃罐而不是刀片支架将研磨机从设备中取出，可能会使玻璃罐松动，并导致食物泄漏。	顺时针转动玻璃罐直到其卡紧在刀片支架上，之后再安装到设备上。 逆时针旋转刀片支架即可从设备上拆卸下来，拆卸时不要转动玻璃罐。	从设备上拆卸时，玻璃罐内的食物漏出
4	切碎机安装后无法工作	没有安装切碎机变速箱	先安装切碎机变速箱，之后安装切碎机刀片	当按下任何图标，LED显示灯将亮起3秒钟，但切碎机还未转动

项目	故障	原因	解决方案	表现
5	应用程序账户注册及登录	无法创建账户	<p>以前曾使用该电子邮件地址创建账户</p> <p>请使用不同的电子邮件地址创建新的账户，或继续使用现有的电子邮件为现有账户重置密码</p>	注册新账户时，您将收到下列信息“我们已向您发送了一封电子邮件，您可以重置密码”
		a. 密码错误 b. 账户不存在	a. 点击“忘记密码”可以收到一封电子邮件，将协助您重置密码 b. 点击“没有账户？”以创建一个新账户	您在尝试登录时将收到以下消息“用户名或密码无效”
6	新机设置	设备无法与所需的SSID WIFI连接	<p>检查 WIFI 密码</p> <p>设置路由器使设备通过WIFI连接（有关安装协助，请向路由器制造商查询）</p>	设置失败
		设备无法检测到SSID	<p>路由器WIFI的必须传播2.4赫兹网络SSID</p> <p>路由器中无法隐藏SSID设置（有关安装协助，请向路由器制造商查询）</p>	在新机设置期间，路由器SSID在应用程序中不可见
		在与设备连接时，手机上的WIFI图标一直在闪烁，尝试连接后设置失败	<p>请打开手机GPS，然后再次尝试连接到设备</p>	<p>需要打开手机的GPS来检测设备的应用程序</p> <p>仅在开机时需要此操作</p>
7	手机应用系统出现错误	设备无法连接到WIFI	<p>请参阅路由器手册，查询有关最佳性能距离和可能的障碍干扰。</p> <p>将搅拌机尽可能靠近路由器，以防止WIFI信号丢失</p>	WIFI图表未亮起，没有连接到WIFI网络
		设备没有开启	<p>按下设备侧面的“开”按钮。</p> <p>等待WIFI图表亮起之后再从移动应用程序发送设置。</p>	向设备发送设置时，手机应用系统出现错误

說明手冊

手冊內的插圖僅做說明使用，可能與實際產品不同。

首次使用本電器時，請詳閱下列說明。保留此說明書以備日後參考。

零配件圖示

- | | |
|---------------------------|-----------------------------|
| A. 量杯 (可用洗碗機清洗) | I1. 食物調理器杯蓋* (可用洗碗機清洗) |
| B. 具投料口的壺蓋 (可用洗碗機清洗) | I2. 食物調理器S型刀片* (可用洗碗機清洗) |
| C. 壺口 | I3. 食物調理器的變速器* |
| D. 果汁壺與不可拆卸刀組 (可用洗碗機清洗) | I4. 食物調理器杯* (可用洗碗機清洗) |
| E. 果汁壺把手 | J1. 多功能研磨杯* (可用洗碗機清洗) |
| F. 果汁機底座 | J2. 多功能研磨杯刀組 |
| G. 開/關按鈕 | J3. 多功能研磨器刀組底座* (可用洗碗機清洗) |
| H1. 果昔食譜程式 | |
| H2. 濃湯食譜程式 | *僅適用部分型號 |
| H3. 碎冰食譜程式 | 圖示請見第3~5頁 |
| H4. APP食譜連線程式 | |
| H5. 停止 | |
| H6. 1~5段速按鈕 | |
| H7. 瞬速按鈕 | |
| H8. Wi-Fi連接圖示 | |

安全建議

- 使用本機前，請先拆除並丟棄所有包裝材料。
- 本電器設計不適合體格、感官或精神能力不健全，或者是缺少經驗和知識的人士（包括兒童）使用，除非他們已透過負責他們安全的人士獲得有關使用本電器的監督或說明。
- 請將本電器及其電源線放在兒童拿不到的地方。請監督兒童確保他們不會將本機當成玩具。
- 除非在有人監督的情況下，否則不應由兒童清潔和保養本機。
- 本電器僅可連接至電壓及頻率符合定額規格的電源供應器。
- 如果電源線損壞且/或防護外殼損壞，則需避免再使用或收拾整理此機器。
- 如果本電器或電源線已損壞，則應聯絡伊萊克斯 (Electrolux) 或其服務代理商協助更換，以避免發生危險。
-  請勿將本電器、電源線或插頭浸入水中或其他液體中。
- 操作機器時，請勿在桌子或檯面邊緣使用或放置此機器，也需留意避免放置於熱氣體、瓦斯爐、電爐或加熱烤爐旁。
- 請務必將本電器放置在平坦且平穩的乾燥表面上。
- 此電器無人看管或在更換配件、進行清潔保養前，請務必關閉本電器並中斷其電源。
- 刀片和刀組非常鋒利。可能會有受傷危險。在更換配件、使用後及清潔與保養時，請務必小心。
- 本機連接至電源時和/或本機操作時，請勿接觸刀片或將手及任何器具放入本機中。
- 請勿試圖取下刀片組。
- 電器運轉時請保持雙手和器皿遠離，避免人員受傷或電器損壞。
- 從主機上拿掉攪拌杯時，請確保電器已經關斷電源。
- 攪拌容器內沒有食物或液體時，請不要操作本電器。

- 蓋子沒有蓋好時，請不要操作本電器。
- 在處理大量食材時，請不要連續使用超過3分鐘。在連續3分鐘處理大量食材後，應當讓電器冷卻至少20分鐘後才能再次使用。
- 除冰塊以外，果汁壺請避免用於攪拌或研磨堅硬和乾燥的物體。請使用多功能研磨器配件研磨堅硬和乾燥物體（例如堅果、糖果、米粒等）。
- 將高溫液體倒入果汁壺攪拌時請務必小心，攪拌瞬間產生的熱氣可能導致高溫液體從容器內濺出。
- 使用果汁機攪拌時，請注意食材溫度最高請勿超過90°C
- 不要超過本電器標明的最大裝載量。
- 不要使用本電器攪拌油漆。這是危險的操作，可能導致爆炸。
- 請勿讓電源線接觸灼熱表面，或懸掛在桌子或檯面邊緣。
- 請勿使用其他製造商製造的附件或零件，或非由伊萊克斯（Electrolux）出售的配件或零件，這可能會造成人員傷害。
- 本電器僅供室內使用。
- 本電器僅供一般家庭使用。任何不當使用所導致的損壞，伊萊克斯將不負任何責任。
- 本電器適用在50及60電源頻率下使用。
- 警告：為防止因意外復位熱熔斷路器造成的危險，本產品不得透過外部開關裝置控制，例如計時器，或連接到由公共設施定期打開和關閉的線路。

初次使用前

首次使用本產品前，請拆除所有可能附著在主機或配件上的包裝材料，如塑膠、貼紙和標籤。首次使用前，請先清洗部分容器與配件。有關清洗說明，請參考“清潔與保養”指南。

食材準備：徹底沖洗乾淨，切成4至6片，去掉任何堅硬或較大的種子。去掉水果或蔬菜的厚皮。

產品使用

1 清潔 – 確保使用乾淨的果汁壺/容器，使用前請先沖洗乾淨。

2 插入電源

3 最高可使用容量

果汁壺 – 最多可用以攪拌1.5公升的食材，以避免食材濺出。注意！攪拌高溫食材時，請先讓溫度冷卻至低於90°C再倒入果汁壺中，攪拌量請避免超出果汁壺可用容量的一半，並先以低速攪拌。請留意果汁壺可能會變的非常熱，操作時需小心保護您的手，並適時透過投料口將內部蒸氣排出。

食物調理器 – 調理杯最多可用以切碎0.4公升的食材，以避免食材濺出。

多功能研磨器 – 研磨杯最多可用以切碎0.4公升的食材，以避免食材濺出。

4 果汁壺/配件容器

果汁壺 – 將壺蓋蓋至果汁壺上，確保蓋子緊密貼合。將量杯順時針旋轉安裝在果汁壺蓋上，直至其卡入到位。量杯未裝上壺蓋的情況下，您可以透過投料口持續添加食材。

食物調理器 – 將變速器從底部推入調理杯，順時針旋轉，直至其卡入到位。將切碎刀片放置在食物調理杯中的軸上，然後將刀片向下推到正確位置。蓋上切碎杯蓋子，順時針旋轉直至其卡入到位。

多功能研磨器 – 將多功能研磨器開口向上放置，放入食材。將研磨杯刀片朝上推入刀組底座，直至其牢固就位。將刀組倒置，將其轉入至與研磨杯密合即可。將多功能研磨器倒置，翻轉食材。

5 將果汁壺/配件容器放在果汁機底座上

果汁壺與食物調理器 - 將容器放置於果汁機底座上，把手位於右側。順時針旋轉直至其鎖定到位。(鎖定到位時，請注意容器把手將會面向您。)。接著將食材放入容器中。

多功能研磨器 - 握住研磨器的刀組底座，將組裝好的研磨器放在果汁機底座上。順時針旋轉直至其鎖定到位。鎖定到位時，請注意研磨器的鎖定符號將會面向您。

6 開始使用果汁機 - 按下開/關按鈕。操作面板上的圖示會點亮，照亮顯示幕。**7 選擇正確的速度或內建程式**

有預設速度 1-5，內建食譜程式 - 果昔、濃湯、碎冰、及瞬速模式供您選擇。選定的速度或食譜圖標將會被點亮。您可以點擊速度設置來啟動任何速度，並通過點擊不同的速度，或在速度條上滑動手指來調整速度。選擇瞬速模式可以快速將食材攪打至符合您需求的細緻程度。按下瞬速圖標進入瞬速模式後，速度鍵將開始閃爍，接著可選擇 1-5 段不同的速度。如需使用 APP 操控果汁機，請按下果汁機操作面板上的 APP 圖標並於 APP 中選擇攪打程式。

各配件建議使用的內建程式：

果汁壺- 果昔、濃湯、碎冰、速度(1-5)、瞬速模式

食物調理器與研磨器 - 速度(1-5)、瞬速模式

重要！攪拌機配有雙重安全系統。如配件蓋子未蓋好或配件未鎖定到指定位置，產品將無法啟動，且操作面板將會開始閃爍。這會確保您不會在廚房裡發生嚴重事故。

警告！產品運行期間切勿取掉量杯或蓋子。切勿讓果汁機空轉，果汁機空轉可能導致產品過熱及損壞商品。攪拌期間確保手和餐具不要放置在攪拌配件裡。

8 停止使用 - 果汁機將會持續運轉至內建程式完成，如要手動停止請按停止圖標。**9 用後清潔** - 建議您在使用完畢之後立即清理，以避免食物殘渣乾燥後留在組件裡。

重要！為了避免容器出現細紋，請在每次使用之後用清水沖洗乾淨，以防止食物中的酸性物質或揮發油使塑膠材料脫色。如使用洗碗機清潔，請在放入洗碗機前先用清水稍微沖洗。您也可以於配件容器中倒入溫水並蓋上蓋子，將配件放於主機上攪打清潔。

10 清潔速度 - 清潔果汁壺與研磨器時，以速度 5 運行 30 秒；清潔食物調理器時，以速度 1 運行。**11 拔掉設備的電源插頭。**

清潔及保養

徹底清潔底座和介面 - 關閉果汁機，拔掉電源線。用稍微沾濕的布擦拭果汁機底座。

警告！切勿將主機底座、電源插頭或電源線浸泡在水中或其他液體中。

徹底清潔配件容器 - 拆除所有組件。用水和洗潔劑沖洗刀片。注意！果汁壺刀組不可拆卸。

警告！刀片非常鋒利，清潔時請注意！

請盡情享用您的伊萊克斯新產品！

棄置



本產品或其包裝上的這個標誌說明該產品不可作為家庭垃圾丟棄。回收時，請將產品交由當地回收服務廠商處理，或聯絡當地政府機構尋求協助，以便安全拆除電器電池/零件並正確回收。遵守您所在國家針對電器產品回收和充電電池的規定。

伊萊克斯 (Electrolux) 保留更改產品、資訊和規格的權利，恕不另行通知。

客戶服務

聯繫客服部門時，請確保您已掌握了以下資訊：**型號**、**PNC**、**序號**。此類資訊可在機身上產品標籤上找到。

由於Electrolux堅持持續開發產品的政策，本手冊之中提及的產品規格、顏色、詳細資訊等等均可能隨時更改，恕不另行通知。

伊萊克斯 (Electrolux Group) 果汁機型號: E9TB1-90BP/ E9TB1-90PP 根據NCC低功率電波輻射性電機管理辦法規定: 第十二條 經型式認證合格之低功率射頻電機，非經許可，公司、商號或使用者均不得擅自變更頻率、加大功率或變更原設計之特性及功能。第十四條 低功率射頻電機之使用不得影響飛航安全及干擾合法通信；經發現有干擾現象時，應立即停用，並改善至無干擾時方得繼續使用。前項合法通信，指依電信法規定作業之無線電通信。低功率射頻電機須忍受合法通信或工業、科學及醫療用電波輻射性電機設備之干擾。有鑒於世界各國對綠色環保意識的重視，伊萊克斯依循RoHS「危害性限制物質指令」誠實標示產品化學物質含量，關於本產品的RoHS聲明書，請上伊萊克斯官網-->「支援服務」-->「RoHS聲明書」，依產品類別及型號檢索。

<http://www.electrolux.com.tw/Support/Customer-Care/>

食譜

請確保將您的產品與Master X 應用程式連接，以便您可以充分利用果汁機。共有超過25種快速食譜程式，及超過15種逐步食譜程式，將讓您享受日常烹飪的樂趣。

下表列出了Master 9果汁機的參考食譜，供您參見。

最長攪拌時間(最高盛裝量)	最大容量
2分鐘	1500毫升

建議的攪拌速度					
食譜	食材	數量/重量		攪打時間	速度設置
蔬菜泥	紅蘿蔔	20-160	克	30 秒	5 (最高速)
	馬鈴薯	20-160	克		
	洋葱	20-160	克		
	水	40-320	克		
鳳梨杏桃冰沙	切片鳳梨	250	克	≤ 120 秒	
	杏桃乾	40	克		
	優格乳	300	克		
紅蘿蔔湯	紅蘿蔔	600	克	≤ 60 秒	5 (最高速)
	水	900	毫升		
覆盆子果昔	冷凍覆盆子	250	克	≤ 60 秒	
	香蕉 (½顆)	50	克		
	水	50	克		
	優格乳	300	克		
香蕉巧克力奶昔	牛奶	150-300	毫升	15-30 秒	
	香草冰淇淋	150-300	毫升		
	香蕉	¼ - ½	顆		
	巧克力糖漿	30-60	克		
韭蔥馬鈴薯濃湯	馬鈴薯	200	克	程式設置	
	韭蔥	200	克		
	水	600	克		
鬆餅 (麵糊調製)	小麥麵粉	150	克	30-40 秒	
	鹽	1	少許		
	雞蛋	3	顆		
	牛奶	250	毫升		
	水	140	毫升		
	奶油	50	克		

故障排除

項目	故障	可能原因	解決方案	狀態
1	果汁機不能啟動	沒有按開/關按鈕	確認操控面板上的LED燈是否亮起。若沒有亮，則需按下開關鍵打開果汁機。	LED指示燈沒有亮起
		a. 在選擇內建食譜程式、瞬速或段速之前，果汁壺/配件未正確安裝或未鎖定位。	正確安裝並將果汁壺/配件鎖定位。	a. 所有LED顯示燈 (Wi-Fi除外) 開始閃爍3秒鐘，之後操作介面進入全亮模式。
		b. 在內建程式暫停後，果汁壺/配件未正確安裝或未鎖定位。	a. 按下相對應的按鍵，再次選擇您需要的內建程式/速度。 b. 按下閃爍的內建程式，繼續剛才暫停的模式。	
		a. 開始選擇內建食譜/瞬速/段速前，配件蓋子未蓋好或未正確放置到位。	將蓋子放置或移動到正確的位置。	b. 所有LED顯示燈 (Wi-Fi除外) 開始閃爍3秒鐘，之後回到暫停狀態。
		b. 在內建程式暫停後，配件蓋子未蓋好或未正確放置到位。	a. 按下相對應的按鍵，再次選擇您需要的內建程式/速度。 b. 按下閃爍的內建程式，繼續剛才暫停的模式。	
		馬達過熱	關掉果汁機，拔掉機器電源插頭，等待10分鐘，讓馬達冷卻，然後再次開啟果汁機。	設備關閉，沒有LED顯示燈亮起
		插頭未正確連接在電源插座上，或電源插座無電	檢查插頭與電源插座的連接，或嘗試其他插座	沒有LED顯示燈亮起
		斷電	待供電後再使用本產品	沒有LED顯示燈亮起
在APP應用城市連結模式下，果汁機無法啟動	網路連接斷開。請確認應用程式已連線到果汁機。	APP應用程式無法偵測到果汁機設備。		
功能故障	請與當地客服部門聯繫以獲得進一步幫助。	採取故障排除措施后，機器仍不能正常工作。		

項目	故障	可能原因	解決方案	狀態
2	運行期間馬達停轉	操作過程中，配件容器或蓋子被取掉	操作過程中，配件容器或蓋子應始終安裝好 將配件容器和蓋子正確安裝或放置在設備上以便繼續使用	馬達停止運行 A. 所有LED顯示燈開始閃爍3秒鐘，之後操作介面進入全亮模式。 B. 操作介面繼續處於暫停狀態。
		過熱保護	如果馬達停轉，立刻關閉果汁機，拔掉設備電源插頭，讓設備冷卻至少10分鐘，之後再重新接通電源，打開設備。	設備關閉，沒有LED燈亮起。
		食材尺寸過大	將所有食材切成小塊 拔下插頭10秒鐘，之後插上機器插頭繼續使用	設備關閉，沒有LED燈亮起。
		容器/配件或食材使用不當	容器或配件的使用應與正確的食材相匹配（果汁壺用於攪拌水果和蔬菜）。	設備關閉，沒有LED燈亮起。
		停止計時器被啟動，防止過熱	按下所需的按鈕繼續使用	果汁機以某個速度/瞬速或內建食譜程式連續運行3分鐘後停止。 所有LED顯示燈（Wi-Fi除外）開始閃爍3秒鐘，之後操作介面進入全亮模式
3	研磨器食材漏出	取出研磨器時，因為僅逆時針轉動玻璃罐而非刀組底座。導致玻璃罐與刀組底座鬆開，食材因而漏出。	順時針轉動玻璃罐直到其卡緊在刀組底座上，之後再安裝到果汁機主機上。 逆時針旋轉刀組底座即可從果汁機主機上拆卸下來，拆卸時不要轉動玻璃罐。	拆卸研磨器時，玻璃罐內的食材漏出
4	食物調理器安裝後無法工作	變速器未安裝至調理杯上	先安裝變速箱，之後安裝食物調理器刀片	當按下任何內建程式，LED顯示燈將閃爍3秒鐘，但食物調理器還未轉動

項目	故障	可能原因	解決方案	狀態
5	APP應用程式帳戶註冊及登錄	無法創建帳戶	<p>以前曾使用該電子郵件地址創建帳戶</p> <p>請使用不同的電子郵件地址創建新的帳戶，或繼續使用現有的電子郵件為現有帳戶重置密碼</p>	註冊新帳戶時，收到下列資訊“我們已向您發送了一封電子郵件，您可以重置密碼”
		<p>a. 密碼錯誤</p> <p>b. 帳戶不存在</p>	<p>a. 點擊“忘記密碼”可以收到一封電子郵件，將協助您重置密碼</p> <p>b. 點擊“沒有帳戶？”以創建一個新帳戶</p>	當您嘗試登錄食收到以下訊息：“帳號或密碼無效”
6	果汁機WIFI連線設定	果汁機無法連接到欲連結的WIFI	<p>檢查 WIFI 密碼</p> <p>設置路由器使果汁機透過WIFI連接（有關安裝協助，請向路由器製造商查詢）</p>	設置失敗
		果汁機無法偵測到SSID	<p>路由器需可傳播2.4 GHz網路頻帶</p> <p>路由器中無法隱藏SSID 設置（有關安裝協助，請向路由器製造商查詢）</p>	在連線過程中，手機應用程式無法找到SSID
		在與果汁機連接時，手機上的WIFI圖示一直在閃爍，嘗試連接後設置失敗	<p>請打開手機GPS功能，再次嘗試與果汁機連結</p>	<p>需要打開手機的GPS來偵測果汁機的應用程式</p> <p>僅在連線時需要此操作</p>
7	手機應用程式出現錯誤	果汁機無法連接到WIFI	<p>請參閱路由器使用手冊，查詢有關最佳性能距離和可能的障礙干擾。</p> <p>將果汁機盡可能靠近路由器，以避免搜尋不到WIFI而導致連線中斷</p>	WIFI圖示未亮起，且未連接到WIFI網路
		果汁機沒有開啟	<p>按下設備側面的“開/關”按鈕。</p> <p>等待WIFI圖示亮起之後再從手機APP發送設置。</p>	向果汁機發送設置時，手機應用系統出現錯誤

사용 설명서

사용설명서 내 이미지는 실제 제품 이미지와 다소 차이가 있을 수 있습니다.
제품을 처음 사용하기 전에 모든 지시 사항을 주의 깊게 읽으십시오.
나중에 참고할 수 있도록 이 설명서를 보관해 두시기 바랍니다.

구성 부품

- | | |
|--|---|
| <ul style="list-style-type: none"> A. 측정 컵 (식기세척기 사용가능) B. 블렌더 뚜껑 (식기세척기 사용가능) C. 주둥이 D. 비분리형 칼날이 부착된 블렌더 용기 (식기세척기 사용가능) E. 손잡이 F. 분체 G. On/Off 버튼 H1. 스무디 프로그램 H2. 수프 프로그램 H3. 얼음 분쇄 프로그램 H4. 앱에서 레시피 시작 H5. 프로그램 중지 H6. 속도 1 - 5 H7. 펄스 프로그램 H8. 와이파이 연결 아이콘 | <ul style="list-style-type: none"> I1. 다지기 뚜껑* (식기세척기 사용가능) I2. 다지기 칼날* (식기세척기 사용가능) I3. 다지기 기어박스* I4. 다지기 용기* (식기세척기 사용가능) J1. 분쇄기 용기* (식기세척기 사용가능) J2. 다지기 칼날* J3. 분쇄기 칼날 홀더* (식기세척기 사용가능) |
|--|---|

*특정 모델만 해당됨
사진 페이지 3-5

안전주의 사항

- 제품을 사용하기 전에 모든 포장재를 제거한 다음 안전하게 폐기하십시오.
- 본 제품은 전압 및 주파수가 명판의 규격과 일치하는 전원장치에만 연결하여 사용하여야 합니다.
- 전원 코드가 손상된 경우나 하우징이 손상된 경우에는 제품을 사용하거나 집지 마십시오.
- 제품 또는 전원 코드가 손상된 경우 위험 방지를 위해 Electrolux 또는 공식 서비스센터를 통해 교체해야 합니다.
- 오터베이스에서 저그 (용기) 를 분리하기 전에 반드시 제품 전원을 끄십시오.
- 장시간 사용하지 않거나 액세서리 교체, 청소 또는 정비를 수행하기 전에는 항상 제품 전원을 끄고 전원 공급 장치에서 연결을 끊으십시오.
- 제품이 전원에 연결되어 있을 때 또는 작동 중에는 손이나 식기로 칼날 또는 부속품을 만지거나 건드리지 마십시오.
-  전원 코드가 뜨거운 면에 닿거나 탁자 또는 카운터 모서리에 걸려 있지 않게 하십시오.
- 장치, 전선, 전원코드, 플러그를 물이나 다른 액체에 담그지 마십시오.
- 칼날과 부속품은 매우 날카로우며 부상의 위험이 있습니다. 심각한 부상 또는 제품 손상 위험을 줄일 수 있도록 작동 중에는 제품 가까이 손이나 식기를 대지 마시고, 액세서리를 교체하거나 사용 전, 후, 그리고 청소 및 정비할 때는 주의 하십시오.
- 칼날 부분을 분해하거나 조립하려 하지 마십시오.
- 이 제품은 안전에 관하여 책임이 있는 사람이 제품 사용에 관한 감독 또는 지시를 하는 경우를 제외하면 신체, 감각 또는 지적 능력이 낮거나 경험과 지식이 부족한 사람 (어린이 포함)이 사용하거나 청소 및 정비를 수행해서는 안됩니다.
- 기와 전원 코드를 어린이의 손이 닿지 않는 곳에 두십시오. 어린이가 제품을 가지고 놀지 못하도록 해야 합니다.
- 항상 제품을 평평하고 안정된 건조한 표면에 놓으십시오.
- 제품을 탁자 또는 카운터 가장자리, 가스레인지, 스토브, 전기버너 및 가열된 오븐 근처에 두거나 이러한 곳에서 사용하지 마십시오.
- 제품에 표시된 최대 채움 양을 초과하지 마십시오.
- 많은 양을 조리할 때는 제품을 3분 이상 연속 사용하지 마십시오. 많은 양의 재료를 넣은 상태로 3분 동안 작동시킨 후에는 제품을 최소한 20분간 식힌 후 다시 사용하십시오.
- 본 제품은 각 얼음을 제외하고 냉동 및 단단하고 건조한 재료의 혼합 또는 분쇄에는 사용할 수 없습니다.
- 너무 뜨거운 액체 (최대 90도)를 조리하지 마십시오. (다목적 분쇄기는 60도 이상의 뜨거운 재료를 사용하지 마십시오.)

제품에 뜨거운 액체를 넣고 조리하거나 작동 중 부울 경우 갑작스러운 증기 발생으로 제품에서 액체가 튀어나올 수 있으므로 주의해야 합니다.

- 뚜껑 없이 제품을 작동하지 마십시오
- 저그 (용기)에 식품이나 액체를 넣지 않은 채 제품을 작동시키지 마십시오
- 본 제품을 사용하여 페인트를 섞지 마십시오. 위험합니다. 폭발할 수 있습니다.
- Electrolux 에서 권장하거나 공식 서비스센터에서 판매하는 액세서리나 부품을 사용하여야 합니다. 타 제조업체에서 만든 액세서리나 부품은 사용하지 마십시오. 제품의 오작동, 성능저하 및 부상의 위험이 있습니다.
- 이 제품은 가정용으로 만들어진 제품으로 실내 전용 기기입니다. Electrolux 는 부적절한 용도로 사용하거나 부정확한 사용으로 인해 발생한 손상에 대해 책임을 지지 않습니다.
- 본 제품은 50 과 60 Hz 전원 주파수 모두에서 사용 가능합니다.
- 주의: 우발적인 열 차단 리셋 위험을 방지하기 위해 본 장치는 타이머와 같은 외부 스위치 장치로 연결해서는 안되며 주기적으로 전원이 켜지고 꺼지는 회로에 연결해서는 안됩니다.

시작하기

기기를 처음 사용하기 전에, 부품에 붙어 있는 플라스틱, 스티커, 태그 등 모든 포장재를 제거하십시오. 기기와 부속품을 청소하십시오. 관련 지침을 확인하십시오. “청소와 관리(Cleaning and Care)”.

식재료를 항상 준비하십시오. 깨끗이 씻어서 4-6등분으로 자르고 단단한 씨나 큰 씨를 제거하십시오. 과일이나 야채의 두꺼운 껍질을 벗기십시오.

제품 사용하기

1 청소 - 용기는 반드시 깨끗이 씻어서 사용하십시오.

2 콘센트에 플러그를 끼웁니다

3 최대 부하량

블렌더 - 이 블렌더는 식재료를 최대 1.5L까지 넣어서 갈 수 있습니다. 이 용량을 넘어가면 재료가 밖으로 튀 수 있습니다. **경고** 뜨거운 액체는 식힌 후(최대 90°C) 용기에 넣을 것을 권장합니다. 용기는 반만 채우고 처음에 저속으로 돌리십시오. 블렌더 용기가 점점 뜨거워질 수 있으니 손이 데이지 않게 조심하고 채우기 구멍 사이로 증기를 빼내도록 합니다.

다지기(Chopper) - 식재료를 최대 0.4L까지 다질 수 있습니다. 이 용량을 넘어가면 재료가 밖으로 튀 수 있습니다.

분쇄기(Grinder) - 식재료를 최대 0.25L까지 갈 수 있습니다. 이 용량을 넘어가면 재료가 밖으로 튀 수 있습니다.

4 용기 조절

블렌더 - 용기에 뚜껑을 덮고 꼭 맞게 닫으십시오. 측정컵을 뚜껑에 맞추고 제자리에 찰칵 잠길 때까지 시계 방향으로 돌리십시오. 블렌더의 작동을 멈춘 상태에서 채우기 구멍 사이로 재료를 더 넣을 수 있습니다.

다지기 - 다지기 기어박스를 맨 밑에서부터 다지기 용기에 밀어 넣고 제자리에 찰칵 잠길 때까지 시계 방향으로 돌리십시오. 초퍼 칼날을 초퍼 용기의 탑 부분에 올려 놓고 아래로 눌러서 제자리에 끼워 맞추십시오. 다지기 용기에 뚜껑을 덮고 제자리에 찰칵 잠길 때까지 시계 방향으로 돌리십시오.

분쇄기 - 분쇄기 용기의 개구부가 위로 오게 해서 재료를 채워 넣으십시오. 분쇄기 칼날을 위로 향하게 해서 분쇄기 블레이드 어셈블리 홀더에 꼭 잠길 때까지 누르십시오. 블레이드 어셈블리 홀더를 뒤집어 엮고, 용기를 돌려 끼워서 꼭 닫으십시오. 이렇게 조립한 분쇄기를 뒤집어 놓습니다.

5 용기를 본체에 올리기

블렌더와 다지기 - 손잡이가 오른쪽으로 오게 해서 용기를 본체에 올려 놓으십시오. 제자리에 잠길 때까지 시계 방향으로 돌리십시오. (용기의 위치는 하나로 정해져 있습니다. 손잡이가 앞으로 와야 합니다). 식재료를 용기에 넣으십시오.

분쇄기 - 분쇄기 칼날 홀더를 쥐고 조립한 분쇄기를 본체에 올려 놓으십시오. 제자리에 잠길 때까지 시계 방향으로 돌리십시오. 용기의 위치는 하나로 정해져 있습니다. 용기를 제자리에 오게 했을 때 블레이드 어셈블리 홀더의 잠금 기호가 앞으로 와야 합니다.

6 블렌더 시작하기 - ON/OFF 버튼을 누르십시오. 이 아이콘들이 켜지면서 디스플레이에 불이 들어옵니다. 버튼을 누르면 디스플레이에 불이 들어옵니다.

7 알맞은 속도 또는 프로그램 선택하기

사전설정 속도는 1에서 5까지 있으며 전용 레시피 프로그램은 스무디, 수프, 얼음 분쇄, 펄스 모드 중에서 선택할 수 있습니다. 선택한 속도 또는 레시피 프로그램에 불이 들어옵니다. 속도 설정을 눌러서 원하는 속도를 켤 수 있고 다른 속도를 누르거나 속도 바를 손가락으로 밀어서 속도를 조절할 수 있습니다. 펄스(순간작동) 모드를 선택하면 재료를 원하는 농도로 빠르게 혼합할 수 있습니다. 펄스 아이콘을 누르면 펄스 모드로 이동합니다. 펄스와 속도 아이콘이 깜박이기 시작합니다. 1에서 5까지 버튼으로 펄스 속도를 조절할 수 있습니다. 앱에서 받은 프로그램을 실행하려면 '앱에서 레시피 시작' 아이콘을 누르십시오.

블렌더 권장 설정/프로그램 - 스무디, 수프, 얼음 분쇄, 속도(1-5), 펄스 모드.

다지기 및 분쇄기 권장 설정/프로그램 - 속도(1-5), 펄스 모드.

중요 이 블렌더에는 이중 안전 시스템이 탑재되어 있습니다. 블렌더가 가동하지 않고 디스플레이가 깜박이면 뚜껑이나 용기가 제자리에 있지 않은 것입니다. 이는 조리 시 위험한 사고를 당할 염려가 없도록 하기 위한 조치입니다.

경고 블렌더 작동 중에는 절대 측정 컵이나 뚜껑을 제거하지 마십시오. 블렌더를 절대로 내용물 없이 작동시키지 마십시오. 블렌더가 빈 채로 작동하게 되면 과열되고 손상될 수 있습니다. 블렌더 작동 중에 손과 조리 기구가 블렌더 용기에 닿지 않게 하십시오.

- 8 블렌더 작동 중지** - 프로그램이 끝나기 전에는 블렌더가 작동을 멈추지 않습니다. 프로그램을 수동으로 중지하려면, 중지(Stop) 아이콘을 누르십시오.
- 9 사용 후 청소** - 음식을 찌꺼기가 부품에 달라 붙어 있지 않도록 사용 직후 부품을 세척할 것을 권장합니다. **중요** 용기에 잔균열이 생기는 것을 피하려면, 반드시 사용 직후 깨끗한 물로 용기를 행구십시오. 그라야 플라스틱 재질을 변색시키는 식물성 정유나 산성 물질이 눌러 붙지 않습니다. 식기 세척기를 사용하는 경우라도 반드시 그 전에 용기를 깨끗이 행구십시오. 미지근한 물을 용기에 채우고 뚜껑을 덮고 본체에 올려 놓으십시오.
- 10 청소 속도** - 블렌더와 분쇄기는 30초간 속도 5로 돌리고 다지기는 속도 1로 돌리십시오.
- 11 기기 플러그 뽑기**

청소와 관리

본체와 인터페이스 깨끗이 청소하기 - 블렌더 전원을 끄고 플러그를 뽑으십시오. 블렌더 베이스를 물에 적신 천으로 닦으십시오. **경고** 절대로 본체, 플러그, 코드를 물이나 다른 액체에 담그지 마십시오.

용기 깨끗이 청소하기 - 모든 부품을 떼어내십시오. 칼날을 물과 세제로 씻으십시오. 주의! 블렌더 칼날은 떼어낼 수 없습니다. **경고!** 칼날이 매우 날카로우니 조심해서 다루십시오.

새로운 Electrolux 제품으로 즐겁게 요리하세요!

폐기 처리



제품이나 그 포장에 이 기호가 있으면 해당 제품은 가정용 쓰레기로 처리할 수 없다는 뜻입니다. 재활용 쓰레기로 버리려면, 공식 수거 장소나 Electrolux 서비스 센터로 가져 오십시오. 그곳에서 배터리와 전기 부품을 안전하고 전문적인 방법으로 제거하고 재활용할 수 있습니다. 국내 규정에 따라서 전기 부품과 충전 배터리를 분리 수거하십시오.

Electrolux 는 제품, 정보, 사양을 고지 없이 변경할 권리가 있습니다.

고객 관리 및 서비스

서비스 센터에 연락할 때는 모델, PNC, 일련번호를 준비해 주십시오. 이 정보는 제품에 부착된 라벨에서 볼 수 있습니다.

지속적인 제품 개발을 위한 Electrolux의 정책으로 인해 당사 제품의 사양, 색상 및 세부사항 그리고 본 설명서에서 언급된 내용은 통보 없이 변경될 수 있습니다.

레시피

구입하신 전자기기가 Master X App에 연결되어 있는지 확인하십시오. 그래야 블렌더를 최대한으로 활용할 수 있습니다. 매일 요리 하고 싶은 마음이 들게 해줄 25개 이상의 빠른 레시피 프로그램 그리고 15개 이상의 단계별 레시피가 있습니다.

아래 표에 Master 9 Blender 레시피 일반 지침을 안내해 놓았습니다.

최대 처리 시간	최대 용량
2분	1500 ml

권장 블렌딩 속도					
조리법	재료	양		시간	속도
야채 워레 만들기	당근	20-160	g	30 s	5 (최대 속도)
	감자	20-160	g		
	양파	20-160	g		
	물	40-320	g		
파인애플 살구 스무디	파인애플 슬라이스	250	g	≤ 120 s	
	말린 살구	40	g		
	요거트	300	g		
수프	당근	600	g	≤ 60 s	5 (최대 속도)
	물	900	ml		
라즈베리 스무디	냉동 라즈베리	250	g	≤ 60 s	
	바나나(1/2 조각)	50	g		
	물	50	g		
	요거트	300	g		
밀크셰이크	우유	150-300	ml	15-30s	
	바닐라 아이스크림	150-300	ml		
	바나나	¼ - ½	개		
	초콜렛 시럽	30-60	g		
감자 부추 수프	감자	200	g	60s	
	부추	200	g		
	물	600	g		
팬케이크(반죽)	밀가루	150	g	30-40s	
	소금	1	자밤		
	달걀	3	개		
	우유	250	ml		
	물	140	ml		
	버터	50	g		

문제해결

항목	증상	원인	해결	징후
1	블렌더가 작동을 시작하지 않는다	ON/OFF 버튼을 누르지 않았다	UI가 ON 모드인지 확인한다. 아니라면, ON/OFF 버튼을 눌러서 블렌더를 켜다	LED 표시등에 불이 들어오지 않는다
		a. 용기가 프로그램, 펄스 또는 속도 선택 시작 전에 올바르게 설치되어 있지 않거나 제자리에 잠겨 있지 않다 b. 프로그램 일시 정지 후 용기가 올바르게 설치되어 있지 않거나 제자리에 잠겨 있지 않다.	용기를 올바르게 설치하고 잠근다 a. 해당 버튼을 눌러서 선택한 프로그램/속도를 다시 시작한다. b. 깜박이는 버튼을 눌러서 일시정지된 프로그램을 다시 진행한다	a. 모든 LED(Wi-Fi 제외)가 3초 동안 순간작동을 시작한 후 ON로 이동한다
		a. 뚜껑이 프로그램, 펄스 또는 속도 선택 시작 전에 용기에 올바르게 설치되어 있지 않다 b. 프로그램 일시 정지 후 뚜껑이 용기에 올바르게 설치되어 있지 않다.	뚜껑을 올바른 위치에 놓거나 옮긴다 a. 해당 버튼을 눌러서 선택한 프로그램/속도를 다시 시작한다. b. 깜박이는 버튼을 눌러서 일시정지된 프로그램을 다시 진행한다	b. 모든 LED(Wi-Fi 제외)가 3초 동안 순간작동을 시작한 후 일시정지 상태로 되돌아간다.
		모터가 과열되었다	블렌더 전원을 끄고 플러그를 빼고 10분 동안 모터의 열이 식을 때까지 기다린 후 블렌더를 다시 켜다	기기의 전원이 꺼지고 LED 표시등에 불이 들어오지 않는다
		플러그가 콘센트에 올바르게 연결되어 있지 않거나 전원 콘센트에 전원이 없다	플러그와 콘센트의 연결 상태를 확인해보고 아니면 다른 콘센트를 사용한다	LED 표시등에 불이 들어오지 않는다
		정전	정전이 끝나서 다시 전원이 들어올 때까지 기다린다.	LED 표시등에 불이 들어오지 않는다
		APP_Mode에서는 블렌더를 가동할 수 없다.	블렌더의 네트워크 연결이 끊겨 있다 블렌더에 무선 네트워크가 작동하고 있는지 확인한다.	앱이 기기를 탐지할 수 없다
		가능 결함	지역 서비스 지원 센터에 연락해 추가 지원을 문의한다	문제해결 조치를 취한 후에도 기기가 작동하지 않는다.

항목	증상	원인	해결	징후
2	모터가 작동 중에 갑자기 멎는다	용기나 뚜껑이 작동 중에 벗겨진다	용기와 뚜껑은 반드시 작동 중에 고정되어야 한다 사용을 계속하려면 용기와 뚜껑을 기기에 올바르게 설치한다	모터가 작동을 멈춘다 A. 모든 LED가 3초 동안 순간작동을 시작한 후 ON_IDLE로 이동한다. B. UI가 계속 일시정지 상태로 있다
		과열 방지	모터가 갑자기 멈추면 블렌더를 즉시 끄고 플러그를 빼고 10분 이상 열을 식힌 후에 다시 플러그를 꽂아서 전원을 켜다.	기기의 전원이 꺼지고 LED 표시등에 불이 들어오지 않는다
		식재료가 너무 크다.	모든 재료를 더 작은 크기로 자른다 플러그를 빼고 10초 동안 기다린 후 다시 플러그를 꽂아서 사용한다	기기의 전원이 꺼지고 LED 표시등에 불이 들어오지 않는다
		용기/부속품 또는 식재료를 잘못 사용	용기와 부속품은 그에 맞는 식재료에 사용해야 한다. (용기는 과일과 야채 블렌딩에 사용한다)	기기의 전원이 꺼지고 LED 표시등에 불이 들어오지 않는다
		과열 방지를 위해 중지 타이머가 작동한다	원하는 버튼을 눌러서 사용을 계속한다	기기가 하나의 속도, 펄스 또는 프로그램에서 3분 동안 연속으로 작동한 후 멈춘다 모든 LED(Wi-Fi 제외)가 3초 동안 순간작동을 시작한 후 ON_IDLE로 이동한다
3	분쇄기 용기 누수	칼날 홀더 말고 유리 용기를 시계 반대 방향으로 돌려서 분쇄기를 기기에서 분리하면 유리 용기가 느슨해져서 내용물이 새어 나올 수 있다.	유리 용기를 기기에 설치하기 전에 블레이드 어셈블리 홀더에 꼭 조여질 때까지 시계 방향으로 돌린다 칼날 홀더만 시계 반대 방향으로 돌려서 기기에서 분리한다 이때 유리 용기를 돌려서 분리하지 않도록 한다	유리 용기를 기기에서 분리할 때 그 안에 든 내용물이 새어 나온다
4	다지기를 설치했는데 작동하지 않는다	다지기 기어박스를 초퍼에 조립하지 않았다	어셈블리 다지기 기어박스를 먼저 설치하고 그 다음에 다지기 칼날을 설치한다	아무 아이콘이나 누르면 모든 LED가 3초 동안 깜박이고 다지기가 작동하지 않습니다

항목	증상	원인	해결	징후
5	앱 계정 등록 및 로그인	계정을 만들 수 없다	이 이메일 주소로 만든 계정이 이미 있다. 다른 이메일 주소로 새 계정을 만들거나 비밀번호를 재설정해서 기존의 계정을 계속 사용한다.	새 계정을 등록하면 다음과 같은 메시지가 전송된다 “비밀번호 재설정 이메일을 보내 드렸습니다”
		a. 비밀번호 오류 b. 계정이 존재하지 않는다	a. “비밀번호 분실”을 클릭하고 비밀번호 재설정 이메일을 수신한다 b. “계정이 없나요?”를 클릭하고 새 계정을 만든다	“잘못된 ID 또는 비밀번호로 로그인하려고 시도하면 다음과 같은 메시지를 수신한다
6	기기 온보딩	기기를 원하는 SSID WIFI에 연결할 수 없다	WIFI 비밀번호를 재입력한다 기기가 WIFI에 연결되도록 라우터를 셋업한다(라우터 제조업체에게 셋업 지원을 문의한다)	셋업 실패
		기기가 SSID를 탐지할 수 없다	라우터 WIFI가 2.4 GHZ 네트워크 SSID를 송출해야 한다 라우터의 SSID 설정을 숨길 수 없다(라우터 제조업체에 셋업 지원을 문의한다)	라우터 SSID가 온보딩 중에 앱에 보이지 않는다
		기기 연결 과정 중에, 휴대폰의 WIFI 아이콘이 계속 깜박이고 연결을 시도했지만 셋업에 실패한다	휴대폰 GPS를 활성화하고 온보딩 중에 기기 연결을 다시 시도한다	기기 APP를 탐지하려면 휴대폰 GPS를 활성화해야 한다. 이것은 온보딩에만 필요하다
7	휴대폰 기기의 오류	기기가 WIFI에 연결되어 있지 않다	최적 성능 거리와 가능한 장애물 간섭에 관하여 라우터 매뉴얼을 참조한다. WIFI 신호가 끊기지 않도록 블렌더를 가능한 한 라우터에 가깝게 놓는다	WIFI 아이콘이 꺼져 있고 WIFI 네트워크에 연결되어 있지 않다
		기기가 켜지지 않는다	기기 옆면의 On 버튼을 누른다 WIFI 아이콘에 불이 들어오기를 기다린 후 모바일 애플리케이션에서 설정을 보낸다	설정을 기기에 발송할 때 휴대폰 애플리케이션에 오류가 있다

BUKU PETUNJUK

- Grafik dan gambar di dalam buku petunjuk ini hanya sebagai ilustrasi dan produk dalam gambar bisa berbeda dengan aslinya.
- Bacalah semua petunjuk dengan cermat sebelum menggunakan perabot untuk pertama kalinya.
- Simpanlah buku petunjuk ini untuk acuan di masa mendatang.

KOMPONEN

- A. Gelas ukur (bisa dibersihkan dengan mesin pencuci piring)
- B. Tutup blender dengan lubang tuang (bisa dibersihkan dengan mesin pencuci piring)
- C. Corong
- D. Gelas blender (Gelas blender dengan mata pisau permanen (bisa dibersihkan dengan mesin pencuci piring))
- E. Pegangan
- F. Bodi Unit
- G. Tombol On/Off
- H1. Program smoothie (tombol smoothie)
- H2. Program sup (tombol sup)
- H3. Program penghancur es (tombol penghancur es)
- H4. Mulai resep dari Aplikasi (tombol ponsel)
- H5. Tombol Stop (tombol stop)
- H6. Kecepatan 1 - 5 (tombol kecepatan 1 - 5)
- H7. Program Pulse (tombol Pulse)
- H8. Tombol koneksi Wifi
- I1. Tutup penyacah* (bisa dibersihkan dengan mesin pencuci piring)
- I2. Mata pisau penyacah* (bisa dibersihkan dengan mesin pencuci piring)
- I3. Gir penyacah*
- I4. Gelas penyacah* (bisa dibersihkan dengan mesin pencuci piring)
- J1. Gelas penggiling* (bisa dibersihkan dengan mesin pencuci piring)
- J2. Mata pisau penggiling*
- J3. Dudukan mata pisau penggiling* (bisa dibersihkan dengan mesin pencuci piring)

*Hanya model tertentu

Gambar halaman 3-5

SAFETY ADVICE

- Kelupas dan buang semua bahan pembungkus sebelum menggunakan perabot ini.
- Perabot ini tidak dimaksudkan untuk digunakan oleh orang (termasuk anak-anak) dengan kemampuan fisik, indera, atau mental yang kurang, atau kurang pengalaman dan pengetahuan, kecuali jika mereka telah diberi petunjuk atau diawasi dalam menggunakan perabot ini oleh orang yang bertanggung jawab atas keselamatan mereka.
- Jauhkan perabot dan kabel dayanya dari jangkauan anak-anak. Anak-anak harus diawasi untuk memastikan bahwa mereka tidak bermain-main dengan perabot ini.
- Pembersihan dan perawatan oleh pengguna tidak boleh dilakukan oleh anak-anak tanpa pengawasan.
- Perabot ini hanya boleh dihubungkan ke catu daya yang tegangan dan frekuensinya sesuai dengan spesifikasi pada pelat rating-nya.
- Jangan sekali-kali menggunakan atau mengangkat perabot apabila terdapat kerusakan pada kabel dan/atau kerangka bodi.
- Jika perabot atau kabel dayanya rusak, pengantiannya harus dilakukan oleh Electrolux atau agen servisnya untuk menghindari bahaya.
-  Jangan merendam perabot, kabel dayanya, atau stekernya di dalam air atau cairan apa pun.
- Jangan menggunakan atau menempatkan perabot di dekat pinggir meja atau konter, di dekat kompor gas, kompor minyak, kompor listrik, atau oven yang panas.
- Selalu tempatkan perabot di atas permukaan yang datar, rata, dan kering.
- Selalu matikan perabot dan lepaskan dari catu daya jika akan ditinggal tanpa diawasi dan sebelum mengganti aksesoris, membersihkan, atau merawatnya.
- Mata pisau dan sisipan sangat tajam. Dapat menyebabkan cedera. Berhati-hatilah saat mengganti aksesoris, setelah menggunakan, dan selama membersihkan dan melakukan perawatan.

- Jangan sekali-kali menyentuh mata pisau dengan tangan atau dengan alat lain saat perabot tersambung ke sumber listrik dan/atau selama sedang dioperasikan.
- Jangan berusaha membongkar komponen mata pisau.
- Jauhkan tangan atau alat lainnya saat perabot beroperasi untuk menghindari risiko cedera parah pada pengguna atau kerusakan pada perabot
- Pastikan perabot dalam keadaan mati sebelum mengangkat gelas dari bodi motor.
- Jangan mengoperasikan perabot tanpa bahan makanan atau cairan di dalam gelas.
- Jangan sekali-kali mengoperasikan perabot jika tutup tidak terpasang.
- Pastikan perabot sudah dimatikan sebelum membuka tutup bercorong dari bodi unit. Jangan mengoperasikan perabot terus-menerus selama lebih dari 2 menit dengan muatan berat, berikan jeda waktu pendinginan selama minimal 5 menit sebelum mengoperasikannya kembali.
- Gelas tidak dapat digunakan untuk memblender bahan makanan yang keras dan kering, kecuali es batu. Gunakan pisau serbaguna untuk menggiling bahan makanan yang keras dan kering (seperti kacang, permen, beras, dsb...)
- Berhati-hatilah saat menuang cairan panas ke dalam gelas karena dapat terciprat yang disebabkan oleh penguapan seketika.
- Jangan sekali-kali memproses cairan mendidih (maks 90°C).
- Jangan mengisi melebihi batas volume maksimal yang tertera pada perabot
- Jangan menggunakan perabot untuk mengaduk cat. Bahaya, dapat menyebabkan ledakan!
- Jangan biarkan kabel listriknya bersentuhan dengan permukaan panas atau tergantung di tepi meja atau konter.
- Jangan sekali-kali menggunakan aksesoris atau komponen yang dibuat oleh produsen lain yang tidak disarankan atau dijual oleh Electrolux karena dapat menimbulkan risiko cedera.
- Perabot ini hanya untuk penggunaan dalam ruangan.
- Perabot ini dimaksudkan hanya untuk penggunaan dalam rumah tangga. Electrolux tidak bertanggung jawab atas kemungkinan kerusakan yang disebabkan oleh penggunaan yang tidak sesuai atau tidak benar.
- Perabot ini ideal untuk dioperasikan pada frekuensi 50Hz maupun 60Hz. **PERHATIAN:** Untuk menghindari bahaya karena pemutusan termal tiba-tiba, perabot tidak boleh digunakan bersama dengan perangkat saklar eksternal, seperti timer, atau disambungkan ke sirkuit yang secara teratur dihidupkan dan dimatikan oleh peralatan tersebut.

SEBELUM MENGGUNAKAN

Sebelum menggunakan perabot untuk pertama kali, buang semua bahan pembungkus plastik dan kelupas stiker atau label yang mungkin menempel pada komponen. Bersihkan perabot dan aksesorinya sesuai petunjuk di bagian: "Pembersihan dan Perawatan".

Persiapkan bahan makanan: Cuci bersih dan potong menjadi 4 sampai 6 bagian, buang biji yang berukuran besar atau keras. Kupas kulit yang keras pada buah atau sayuran.

MENGGUNAKAN PERABOT

1 Membersihkan - Gunakan gelas yang bersih, cuci dahulu sebelum digunakan.

2 Tancapkan steker ke stopkontak

3 Volume maksimum

Blender - Agar tidak tumpah, bahan makanan yang diproses dengan blender ini maksimum bervolume 1,5 L. **PERINGATAN!** Sebaiknya dinginkan cairan panas terlebih dulu (maks. 90 °C) sebelum dimasukkan ke dalam gelas. Isi gelas hanya setengahnya dan mulailah mengolah dengan kecepatan rendah. Gelas blender dapat menjadi panas, pastikan tangan Anda terlindungi dan keluarkan uap terlebih dulu melalui lubang tuang.

The blender jug can become very warm, operate with caution to protect your hands and to ventilate steam out through the filler hole.

Penyacah - Agar tidak tumpah, bahan makanan yang diproses dengan penyacah ini maksimum bervolume 0,4 L.

Penggiling - Agar tidak tumpah, bahan makanan yang diproses dengan penggiling ini maksimum bervolume 0,25 L.

4 Memasang gelas

Blender - Pasang tutup pada gelas blender dan kencangkan dengan erat. Pasang gelas ukur pada tutup dengan cara memutarkannya ke kanan sampai posisinya terkunci. Bahan makanan lain dapat ditambahkan melalui lubang tuang ketika blender tidak sedang dioperasikan.

Penyacah - Tekan gir penyacah masuk ke gelas penyacah dari arah bawah dan putar ke kanan sampai posisinya terkunci. Pasang pisau penyacah pada bagian ujung gir di dalam gelas penyacah, lalu tekan mata pisau ke bawah sampai posisinya terkunci. Pasang tutup penyacah pada gelas dan putar ke kanan sampai posisinya terkunci.

Penggiling - Pegang gelas penggiling dengan bagian mulut menghadap ke atas, lalu masukkan bahan makanan yang akan diolah. Pasang mata pisau penggiling dengan posisi menghadap ke atas pada dudukan mata pisau hingga posisinya terkunci. Balikkan posisi dudukan mata pisau dan pasang ke gelas sampai terkunci rapat. Pasang ke bodi unit dan bahan makanan siap untuk diproses.

5 Memasang gelas ke bodi unit

Blender dan penyacah - Pasang gelas ke bodi unit dengan posisi pegangan di sebelah kanan. Putar ke kanan hingga posisinya terkunci. (Gelas hanya dapat dipasang pada satu posisi, yakni bagian pegangan menghadap ke arah Anda). Masukkan bahan makanan ke dalam gelas.

Penggiling - Pegang dudukan dan mata pisau penggiling lalu pasang pada bodi unit. Putar ke kanan hingga posisinya terkunci. Gelas hanya dapat dipasang pada satu posisi, pastikan simbol kunci pada dudukan mata pisau menghadap ke arah Anda saat memasang gelas.

6 Hidupkan blender

- Tekan tombol ON/OFF. Tombol akan menyala dan layar menjadi terang.

7 Pilih kecepatan atau program yang diinginkan

Tersedia opsi kecepatan 1-5, program resep khusus - smoothie, sup, penghancur es, dan mode Pulse.

Kecepatan atau program resep yang dipilih akan menyala. Kecepatan dapat diaktifkan dengan cara mengetuk pengatur dan menyatel kecepatan dengan mengetuk angka, atau geser jari pada sepanjang bilah kecepatan. Dengan mode Pulse, bahan makanan dapat diblender dengan cepat untuk menghasilkan konsistensi yang diinginkan. Tekan tombol Pulse untuk memulai mode Pulse. Tombol Pulse dan tombol kecepatan akan mulai berkedip. Tekan angka 1 hingga 5 untuk menjalankan Pulse dengan kecepatan yang berbeda. Tekan tombol Mulai resep dari Aplikasi dengan ikon ponsel untuk menjalankan program yang diterima dari aplikasi.

Rekomendasi pengaturan/program untuk Blender - smoothie, sup, penghancur es, Kecepatan (1-5), mode Pulse.

Rekomendasi pengaturan/program untuk Penyacah dan Penggiling - Kecepatan (1-5), mode Pulse.

PENTING! Blender dilengkapi dengan sistem pengaman ganda. Perabot tidak akan beroperasi dan layar akan berkedip jika posisi tutup atau gelas tidak terpasang dengan benar. Dengan fitur ini, Anda tidak akan mengalami kecelakaan yang tidak diinginkan di dapur.

PERINGATAN! Jangan sekali-kali membuka gelas ukur atau tutup saat perabot dioperasikan. Jangan mengoperasikan blender jika gelas kosong karena dapat menyebabkan panas berlebih dan merusak perabot. Jauhkan tangan dan singkirkan benda lain di dekat blender saat sedang beroperasi.

8 Menghentikan perabot

- Blender akan beroperasi sampai program selesai. Untuk menghentikan program secara manual, tekan tombol Stop.

9 Membersihkan setelah penggunaan

- Sebaiknya langsung cuci komponen setelah selesai digunakan agar sisa bahan makanan tidak menempel.

PENTING! Untuk menghindari keretakan pada gelas, selalu bilas dengan air bersih setelah digunakan. Hal ini akan mencegah kerusakan pada plastik yang disebabkan oleh asam atau minyak esensial dari bahan makanan yang diolah. Bilas gelas hingga bersih bahkan sebelum memasukkannya ke dalam mesin pencuci piring. Isi gelas dengan air hangat-hangat kuku, pasang tutup, dan pasang gelas ke bodi unit.

10 Kecepatan pembersihan

- Pilih kecepatan 5 untuk Blender dan Penggiling dan jalankan selama 30 detik, pilih kecepatan 1 untuk Penyacah.

11 Cabut steker perabot dari stopkontak

PEMBERSIHAN DAN PERAWATAN

Membersihkan bodi dan antarmuka blender - Matikan blender dan cabut steker dari stopkontak. Lap bodi blender dengan kain lembap.

PERINGATAN! Jangan sekali-kali merendam bodi blender, steker, atau kabel di dalam air atau cairan lainnya.

Membersihkan gelas secara menyeluruh - Lepas semua komponen. Cuci mata pisau dengan air dan deterjen. Catatan! Mata pisau Blender tidak dapat dilepas.

PERINGATAN! Hati-hati, mata pisau sangat tajam!

Selamat menggunakan produk Electrolux baru Anda!

MEMBUANG PERABOT



Simbol ini pada produk atau kemasan menandakan bahwa produk ini tidak boleh dibuang sebagai limbah rumah tangga. Untuk mendaur ulang produk, bawa ke tempat pembuangan resmi atau ke pusat servis Electrolux untuk melepas atau mendaur ulang baterai dan komponen listrik secara aman dan benar. Patuhi aturan nasional terkait pengumpulan limbah elektronik dan baterai isi ulang.

Electrolux berhak mengubah produk, informasi, dan spesifikasi tanpa pemberitahuan.

LAYANAN KONSUMEN DAN SERVIS

Sebelum menghubungi Pusat Servis, persiapkan data berikut ini: **Model, PNC, Nomor Seri**. Informasi tersebut dapat ditemukan pada pelat spesifikasi.





Sesuai kebijakan pengembangan produk Electrolux secara berkelanjutan; spesifikasi, warna, dan detail produk dan rincian yang tercantum dalam buku panduan ini dapat diubah tanpa pemberitahuan sebelumnya.

RESEP

Pastikan perabot terhubung ke aplikasi Master X App untuk mendapatkan performa blender yang optimal. Tersedia >25 Program Resep Kilat & >15 Resep Lengkap untuk inspirasi memasak sehari-hari.

Berikut adalah tabel yang berisi panduan Resep umum dengan Master 9 Blender.

DURASI WAKTU PEMROSESAN MAKSIMAL	KAPASITAS MAKSIMAL
2 menit	1500 ml

KECEPATAN YANG DISARANKAN					
Resep	Bahan-bahan	Banyaknya		Waktu	Kecepatan
Puree sayuran mentah	Wortel	20-160	g	30 s	5 (Maksimal)
	Kentang	20-160	g		
	Bawang bombai	20-160	g		
	Air	40-320	g		
Smoothie nanas-aprikot	Irisan nanas	250	g	≤ 120 s	
	Aprikot kering	40	g		
	Yogurt	300	g		
Sup	Wortel	600	g	≤ 60 s	5 (Maksimal)
	Air	900	ml		
Smoothie rasberi	Rasberi beku	250	g	≤ 60 s	
	Pisang (½ buah)	50	g		
	Air	50	g		
	Yogurt	300	g		
Milkshake	Susu	150-300	ml	15-30s	
	Es krim vanila	150-300	ml		
	Pisang	¼ - ½	pcs		
	Sirup cokelat	30-60	g		
Sup kentang daun bawang	Kentang	200	g	60s	
	Daun bawang	200	g		
	Air	600	g		
Panekuk (Adonan)	Terigu 1	150	g	30-40s	
	Garam	1	sejumput		
	Telur	3	Butir		
	Susu	250	ml		
	Air	140	ml		
	Mentega	50	g		

PEMECAHAN MASALAH

ITEM	SYMPTOM	CAUSE	SOLUTION	INDICATION
1	Blender tidak dapat dihidupkan	Tombol ON/OFF belum ditekan	Pastikan perabot berada pada mode ON_IDLE. Atau, tekan tombol ON/OFF untuk menghidupkan blender	Semua lampu LED tidak menyala
		a. Gelas tidak terpasang dengan benar atau posisinya tidak terkunci sebelum memilih program, pulse, atau kecepatan b. Gelas tidak terpasang dengan benar atau posisinya tidak terkunci setelah program dihentikan sementara	Pasang gelas dengan benar dan kunci posisinya a. Pilih lagi program/kecepatan dengan menekan tombol yang sesuai b. Tekan tombol yang berkedip untuk melanjutkan program yang dihentikan	a. Semua LED (kecuali Wi-Fi) mulai berkedip selama 3 detik lalu muncul tulisan ON_IDLE
		a. Tutup tidak terpasang dengan benar pada Gelas sebelum memilih program, pulse, atau kecepatan b. Tutup tidak terpasang dengan benar pada Gelas setelah program dihentikan sementara	Pasang atau Geser tutup ke posisi yang benar a. Pilih lagi program/kecepatan dengan menekan tombol yang sesuai b. Tekan tombol yang berkedip untuk melanjutkan program yang dihentikan	b. Semua LED (kecuali Wi-Fi) mulai berkedip selama 3 detik lalu kembali ke status PAUSED
		Suhu motor terlalu panas	Matikan Blender, cabut steker, tunggu selama 10 menit sampai suhu motor agak dingin sebelum dihidupkan kembali	Perabot mati dan semua indikator LED tidak menyala
		Steker tidak ditancapkan dengan benar ke stopkontak atau tidak ada aliran listrik dari stopkontak	Periksa sambungan steker ke stopkontak atau coba gunakan stopkontak lain	Semua lampu LED tidak menyala
		Mati listrik	Tunggu hingga listrik kembali hidup untuk menggunakan perabot	Semua lampu LED tidak menyala
		Dalam APP_Mode, blender tidak dapat beroperasi	Blender tidak tersambung ke internet Pastikan jaringan nirkabel berfungsi pada Blender	APP tidak dapat mendeteksi perabot
		Masalah Fungsional	Hubungi pusat servis setempat untuk mendapatkan bantuan lebih lanjut	Perabot tidak dapat beroperasi setelah langkah-langkah pemecahan masalah dilakukan

ITEM	SYMPTOM	CAUSE	SOLUTION	INDICATION
2	Motor macet selama pengoperasian	Gelas atau Tutup lepas selama Pengoperasian	Gelas dan Tutup harus selalu terpasang selama pengoperasian Pasang dan posisikan Gelas dan Tutup dengan benar pada perabot untuk melanjutkan penggunaan	Motor berhenti beroperasi a. Semua LED mulai berkedip selama 3 detik lalu menampilkan ON_IDLE. b. Layar menampilkan status PAUSED
		Perlindungan dari Panas Berlebih	Jika motor macet, segera matikan blender, cabut steker perabot, dan biarkan dingin selama minimal 10 menit sebelum ditancapkan dan dihidupkan kembali	Perabot mati dan semua indikator LED tidak menyala
		Bahan makanan yang diolah terlalu besar	Potong bahan makanan menjadi berukuran lebih kecil Cabut steker selama 10 detik lalu tancapkan kembali untuk melanjutkan penggunaan	Perabot mati dan semua indikator LED tidak menyala
		Kesalahan penggunaan Gelas/ Aksesori atau Bahan Makanan	Penggunaan Gelas dan Aksesori harus sesuai dengan bahan makanan yang tepat (Gelas digunakan untuk mengolah Buah dan Sayuran)	Perabot mati dan semua indikator LED tidak menyala
		Timer Berhenti Diaktifkan untuk mencegah panas berlebih	Tekan tombol yang diinginkan untuk melanjutkan penggunaan	Perabot beroperasi pada satu kecepatan, pulse, atau program secara terus-menerus selama 3 menit lalu berhenti Semua LED (kecuali Wi-Fi) mulai berkedip selama 3 detik lalu menampilkan ON_IDLE
3	Gelas Penggiling Bocor	Melepaskan Penggiling dari Perabot dengan memutar ke kiri Gelas Kaca, dan bukan memegang bagian dudukan mata pisau dapat melonggarkan posisi gelas dan menyebabkan kebocoran	Putar Gelas Kaca ke kanan hingga terpasang erat pada dudukan mata pisau sebelum dipasang pada perabot Putar BAGIAN dudukan mata pisau ke kiri untuk melepaskannya dari Perabot, Jangan memutar Gelas Kaca untuk melepaskannya	Bahan makanan merembes keluar dari Gelas Kaca saat dilepas dari Perabot

ITEM	SYMPTOM	CAUSE	SOLUTION	INDICATION
4	Penyacah tidak dapat beroperasi setelah dipasang	Gir penyacah tidak dipasang dengan benar pada mata pisau penyacah	Pasang gir penyacah terlebih dulu, lalu pasang mata pisau penyacah	Saat ada tombol yang ditekan, semua LED akan berkedip selama 3 detik dan penyacah akan berhenti beroperasi
5	Registrasi dan Login Akun Aplikasi	Tidak dapat membuat Akun	Alamat email sebelumnya sudah digunakan untuk membuat akun Gunakan alamat email lain untuk membuat akun baru atau lanjutkan dengan email tersebut dan minta bantuan atur ulang sandi akun	Anda menerima pesan berikut ini saat mendaftar akun baru "Kami telah mengirimkan email kepada Anda sehingga Anda dapat menyetel ulang sandi" ("We've sent you an email so you can reset your password")
		a. Sandi salah b. Akun tidak ada	a. Klik "lupa sandi" untuk menerima email bantuan atur ulang sandi b. Klik "tidak punya akun?" untuk membuat akun baru	Anda menerima pesan berikut ini saat mencoba login "nama pengguna atau sandi salah" ("invalid username or password")
6	Menyambungkan Perabot	Perabot tidak dapat tersambung ke SSID WIFI yang diinginkan	Masukkan ulang sandi WIFI Atur router agar mengizinkan Perabot tersambung ke WIFI (Hubungi produsen router Anda untuk bantuan konfigurasi)	Konfigurasi Gagal
		Perabot tidak dapat mendeteksi SSID	WIFI router harus memancarkan SSID jaringan 2.4 GHZ SSID pada Router tidak boleh disetel ke Tersembunyi/Hidden (Hubungi produsen router Anda untuk bantuan konfigurasi)	SSID router tidak terlihat di Aplikasi saat proses penyambungan
		Selama menyambungkan ke Perabot, ikon WIFI di ponsel terus berkedip dan konfigurasi gagal setelah berupaya menyambungkan	Aktifkan GPS di ponsel dan coba lagi menyambungkan Perabot	GPS di ponsel harus diaktifkan agar dapat mendeteksi Aplikasi Perabot Ini hanya diperlukan untuk menyambungkan

ITEM	SYMPTOM	CAUSE	SOLUTION	INDICATION
7	Kesalahan pada Aplikasi Seluler	Perabot tidak tersambung ke WIFI	<p>Lihat Buku Panduan untuk Router terkait jarak pengoperasian optimal dan kemungkinan gangguan interferensi</p> <p>Letakkan blender sedekat mungkin dengan router agar sinyal WIFI mudah terdeteksi dan tidak terputus</p>	Ikon WIFI mati dan tidak tersambung ke jaringan WIFI
		Perabot belum dihidupkan	<p>Tekan tombol ON di bagian samping Perabot</p> <p>Tunggu sampai Ikon WIFI menyala sebelum memilih pengaturan dari Aplikasi Seluler</p>	Kesalahan pada Aplikasi Ponsel saat memilih pengaturan Perabot

คู่มือแนะนำการใช้งาน

ภาพกราฟิกและภาพร่างในคู่มือนี้มีไว้เพื่อประกอบคำอธิบายเท่านั้นและอาจจะแตกต่างจากผลิตภัณฑ์จริง
กรุณาอ่านคำแนะนำทั้งหมดอย่างละเอียดก่อนใช้งานเครื่องเป็นครั้งแรก
เก็บคู่มือนี้ไว้สำหรับอ้างอิงในอนาคต

ส่วนประกอบ

- | | |
|--|---|
| A. ถ้วยตวง (ล้างด้วยเครื่องล้างจานได้) | II. ฝาโกสลับ* (ล้างด้วยเครื่องล้างจานได้) |
| B. ฝาปิดโถปั่นผสมพร้อมช่องเติมอาหาร (ล้างด้วยเครื่องล้างจานได้) | 12. โคมืดโกสลับ* (ล้างด้วยเครื่องล้างจานได้) |
| C. พาย | 13. กระปุกเกียร์ของโกสลับ* |
| D. โถปั่นผสม พร้อมโคมืดแบบถอดไม่ได้ออก (ล้างด้วยเครื่องล้างจานได้) | 14. โคมืด* (ล้างด้วยเครื่องล้างจานได้) |
| E. มือจับ | J1. ตัวโคมืด* (ล้างด้วยเครื่องล้างจานได้) |
| F. ตัวเครื่อง | J2. โคมืดโคมืด* |
| G. ปุ่มเปิด/ปิด | J3. ฐานประกอบชุดโคมืดโคมืด* (ล้างด้วยเครื่องล้างจานได้) |
| H1. ไอคอนโปรแกรมสมูทตี้ | *บางรุ่นเท่านั้น |
| H2. ไอคอนโปรแกรมซูป | ภาพหน้า 3-5 |
| H3. ไอคอนโปรแกรมน้ำแข็งบด | |
| H4. ไอคอนเริ่มต้นสูตรอาหารจากแอป | |
| H5. ไอคอนหยุดโปรแกรม | |
| H6. ไอคอนความเร็ว 1-5 | |
| H7. ไอคอนโปรแกรม Pulse | |
| H8. ไอคอนเชื่อมต่อ Wi-Fi | |

คำแนะนำเพื่อความปลอดภัย

- แกะและตั้งวัสดุบรรจุหีบห่ออย่างปลอดภัย ก่อนที่จะใช้งานเครื่องปั่น
- เครื่องปั่นไฟฟ้านี้ไม่ได้ออกแบบมาเพื่อให้บุคคล (รวมถึงเด็ก) ต่อไปนี้ใช้งานกลาหรือ บุคคลผู้มีความบกพร่องทางร่างกาย ทางประสาทสัมผัสหรือทางจิตรวมถึงผู้ที่ขาดประสบการณ์และความรู้ เว้นแต่จะอยู่ภายใต้การดูแลหรือการแนะนำโดยผู้ที่รับผิดชอบความปลอดภัยของบุคคลเหล่านั้น
- เก็บเครื่องปั่นและสายไฟให้พ้นมือเด็ก ผู้ใหญ่ควรดูแลไม่ให้เด็กเล่นเครื่องปั่น
- เด็กไม่ควรเป็นผู้ทำความสะอาดและบำรุงรักษาเครื่อง เว้นแต่จะมีผู้ควบคุมดูแล
- เครื่องปั่นไฟฟ้าต้องต่อเข้ากับแหล่งจ่ายไฟที่มีแรงดันไฟฟ้าและความถี่สอดคล้องกับค่าที่ระบุบนป้ายแสดงข้อมูลทางเทคนิคเท่านั้น!
- ห้ามใช้หรือจับเครื่องปั่น ถ้าสายไฟและ/หรือตัวเครื่องชำรุดเสียหาย
- หากสายไฟชำรุด ต้องส่งให้ ศูนย์บริการ Electrolux หรือช่างซ่อมบำรุง จัดการเปลี่ยนใหม่เพื่อป้องกันอันตราย
-  ห้ามจุ่มอุปกรณ์ สายไฟ และปลั๊กในน้ำหรือของเหลวชนิดอื่น ๆ
- ห้ามใช้งานหรือวางเครื่องปั่นใกล้กับขอบโต๊ะขณะใช้งาน หรือใกล้กับโอโรนเตาไฟ เตาไฟฟ้า หรือเตาอบที่ร้อนอยู่
- วางเครื่องปั่นบนพื้นราบที่เรียบเสมอกันและแห้ง
- ต้องปิดเครื่องปั่นและถอดปลั๊กออกจากแหล่งจ่ายไฟทุกครั้งหากไม่ได้ใช้งานรวมถึงก่อนเปลี่ยนอุปกรณ์เสริม ทำความสะอาดหรือบำรุงรักษา
- โคมืดและชิ้นส่วนสำหรับปั่นคั้นนมมาก อาจทำให้ได้รับบาดเจ็บได้ ต้องใช้ความระมัดระวังเมื่อทำการเปลี่ยนอุปกรณ์เสริม หลังการใช้งาน รวมถึงระหว่างทำความสะอาดและบำรุงรักษา
- ห้ามใช้มือหรืออุปกรณ์เครื่องใช้ในครัวใดๆ ไปสัมผัสกับโคมืดหรือชิ้นส่วนสำหรับปั่น ในขณะที่เครื่องปั่นยังเสียบปลั๊กอยู่ และ/หรือระหว่างการใช้งาน
- อย่าพยายามถอดชุดโคมืดออก

- ห้ามสอดมือหรือเท้าไปลงขณะเครื่องปั่นกำลังทำงาน เพื่อหลีกเลี่ยงความเสี่ยงต่อการได้รับบาดเจ็บอย่างรุนแรงหรือเกิดความเสียหายต่อเครื่องปั่น
- ตรวจสอบให้แน่ใจว่าได้ปิดสวิตช์เครื่องปั่นก่อนที่จะถอดโถปั่นออกจากตัวเรือนมอเตอร์
- อย่าใช้งานเครื่องปั่นโดยไม่มีอาหารหรือของเหลวอยู่ในโถปั่น
- ห้ามใช้งานเครื่องปั่นโดยไม่มีฝาปิด
- ห้ามใช้งานเครื่องต่อเนื่องนานกว่า 3 นาที เมื่อใช้งานหนัก หลังจากใช้งานหนักเป็นเวลา 3 นาที ควรปล่อยให้เครื่องเย็นลงอย่างน้อย 20 นาที ก่อนเริ่มทำงานอีกครั้ง
- เครื่องปั่นไฟฟ้าไม่สามารถใช้ปั่นหรือบดของแข็งและแห้งได้ ยกเว้นน้ำแข็งก้อนเล็ก
- โปรดใช้ความระมัดระวังหากเทของเหลวร้อนลงไปเครื่องปั่น เพราะไอน้ำที่เกิดขึ้นกะทันหันอาจทำให้ของเหลวร้อนกระเด็นออกมาจากเครื่องปั่นได้
- ห้ามใส่ของเหลวที่มีความร้อนสูง (สูงสุด 90 องศาเซลเซียส)
- ห้ามใส่ของที่ต้องการปั่นเกินขีดสูงสุดที่ระบุไว้บนเครื่องปั่น
- ห้ามใช้เครื่องปั่นในการผสมสี เพราะอาจเกิดอันตราย ทำให้เครื่องระเบิดได้
- อย่าให้สายไฟสัมผัสกับพื้นผิวส่วนที่ร้อนหรือปล่อยให้สายไฟห้อยจากขอบโต๊ะหรือชั้นวาง
- ห้ามใช้อุปกรณ์เสริมหรือชิ้นส่วนที่ผลิตโดยบริษัทผู้ผลิตรายอื่นที่ไม่ได้แนะนำหรือจำหน่ายโดย Electrolux เพราะอาจก่อให้เกิดความเสี่ยงทำให้ร่างกายได้รับบาดเจ็บ
- เครื่องปั่นนี้สำหรับใช้งานภายในอาคารเท่านั้น
- เครื่องปั่นนี้ออกแบบมาเพื่อการใช้งานในครัวเรือนเท่านั้น Electrolux จะไม่รับผิดชอบต่อความเสียหายใดๆ ที่อาจเกิดขึ้นเนื่องจากการใช้งานไม่เหมาะสมหรือไม่ถูกต้อง
- เครื่องใช้ไฟฟ้านี้สามารถใช้งานได้ทั้ง 50 Hz และ 60 Hz
- คำเตือน: เพื่อหลีกเลี่ยงอันตรายจากการรีเซ็ตระบบตัดวงจรเมื่อมีอุณหภูมิสูงอย่างไม่ตั้งใจ ห้ามจ่ายไฟให้แก่เครื่องปั่นผ่านอุปกรณ์สวิตช์ภายนอก เช่น ระบบจับเวลา หรือเชื่อมต่อกับวงจรที่ตามปกติแล้วจะเปิดปิดโดยใช้อุปกรณ์ดังกล่าว

เริ่มต้นใช้งาน

ก่อนใช้งานเป็นครั้งแรก ควรแกะวัสดุบรรจุภัณฑ์ทั้งหมดออก เช่น พลาสติก สติกเกอร์ หรือป้าย ซึ่งอาจจะติดอยู่กับส่วนประกอบของผลิตภัณฑ์ ล้างผลิตภัณฑ์และอุปกรณ์เสริมให้สะอาด ดูคำแนะนำ: “การทำทำความสะอาดและการดูแลรักษา”

เตรียมส่วนผสมก่อนเสมอ: ล้างส่วนผสมให้สะอาด จากนั้นหั่นเป็น 4-6 ชิ้น และนำส่วนผสม ๆ หรือเมล็ดออก ปอกเปลือกผลไม้หรือผักออก

การใช้ผลิตภัณฑ์

1 การทำความสะอาด - ทำความสะอาดโถก่อนจะเริ่มใช้งาน

2 เสียบปลั๊ก

3 ปริมาตรสูงสุด

โถปั่นผสม - คุณสามารถปั่นส่วนผสมในโถปั่นผสมได้ไม่เกิน 1.5 ลิตร เพื่อป้องกันไม่ให้ส่วนผสมหกออกจากโถปั่นผสม

คำเตือน! เราแนะนำให้ควรทำให้อุณหภูมิของเหลวร้อนเย็นลง (ไม่เกิน 90 °C) ก่อนจะเทลงในโถ เทของเหลวลงไปไม่เกินครึ่งโถ แล้วเริ่มปั่นด้วยความเร็วต่ำก่อน โถปั่นผสมอาจจะร้อนมาก ดังนั้นหาจะโรมาป้องกันมือและระบายไอน้ำผ่านช่องกรอง

โถสับ - คุณสามารถสับส่วนผสมในโถสับได้ไม่เกิน 0.4 ลิตร เพื่อป้องกันไม่ให้ส่วนผสมหกออกจากโถสับ

โถบด (J, K, L) - คุณสามารถบดส่วนผสมในโถปั่นผสมได้ไม่เกิน 0.4 ลิตร เพื่อป้องกันไม่ให้ส่วนผสมหกออกจากโถบด

4 การประกอบโถ

โถปั่นผสม - วางฝาปิดลงบนโถปั่นผสม แล้วปิดให้แน่นหนา ติดตั้งถ้วยตวง ลงบนฝาปิด โดยหมุนตามเข็มนาฬิกาจนกว่าจะได้ยินเสียงสติกกลิ้ง คุณสมบัตินี้สามารถเติมส่วนผสมผ่านช่องกรองได้ขณะที่โถปั่นผสมไม่ได้กำลังทำงานอยู่

โถสับ - ต้นกระปุกเกียร์โถสับลงในโถสับจากด้านล่าง จากนั้นให้หมุนตามทิศทางของเข็มนาฬิกาจนกว่าจะได้ยินเสียงสติกกลิ้ง ติดตั้งใบมีดโถสับบนแท่นที่อยู่ในโถสับ แล้วกดใบมีดให้เข้าที่ วางฝาปิดโถสับลงบนโถ จากนั้นหมุนตามทิศทางของเข็มนาฬิกาจนกระทั่งได้ยินเสียงสติกกลิ้ง

โอบด – หงายโอบดขึ้นมา แล้วใส่ส่วนผสมลงไป หงายใบมีดโอบดขึ้น แล้วกดลงในฐานประกอบชุดใบมีดของโอบดจนกระทั่งเข้าที่ คำฐานประกอบชุดใบมีดของโอบดลง แล้วติดตั้งเข้ากับโอบดโดยการหมุนเกลียว จนกระทั่งปิดแน่นหนา จากนั้น คำโอบดลงเพื่อให้ส่วนผสมมาอยู่ด้านล่าง

5 การติดตั้งโอบนตัวเครื่อง

โอบนผสมและโอบสับ – วางโอบลงบนตัวเครื่อง โดยให้มือจับอยู่ทางด้านขวา จากนั้นให้หมุนตามทิศทางของเข็มนาฬิกาจนกว่าจะได้ยินเสียงสล็อตล็อก (โอบติดตั้งเข้ากับตัวเครื่องได้เพียงตำแหน่งเดียวเท่านั้น โดยมีมือจับจะหันมาทางคุณ) ใส่ส่วนผสมลงในโอบ

โอบด – วางฐานประกอบชุดใบมีดของโอบดที่ประกอบเข้ากับใบมีดและโอบดแล้วลงบนตัวเครื่อง จากนั้นให้หมุนตามทิศทางของเข็มนาฬิกาจนกว่าจะได้ยินเสียงสล็อตล็อก โอบติดตั้งเข้ากับตัวเครื่องได้เพียงตำแหน่งเดียวเท่านั้น โดยสัญลักษณ์บนฐานประกอบชุดใบมีดของโอบดจะต้องหันมาทางคุณตอนจัดตำแหน่งของโอบด

6 เริ่มใช้งานโอบนผสม – กดปุ่มเปิด/ปิด โอบคอนจะสว่างขึ้นบนหน้าจอแสดงผล

7 การเลือกความเร็วหรือโปรแกรมหที่เหมาะสม

คุณสามารถเลือกระดับความเร็วที่มีการตั้งค่าไว้ล่วงหน้า 1-5 โปรแกรมทำอาหาร ได้แก่ สมูทตี้, ซุป, น้ำแข็งบด และ โหมด Pulse ได้ ระดับความเร็วและโปรแกรมหทำอาหารที่เลือกไว้จะสว่างขึ้น คุณสามารถเลือกความเร็วได้โดยการแตะบนส่วนการตั้งค่าความเร็ว แล้วปรับความเร็วได้โดยการแตะเลือกความเร็วอื่นหรือเลื่อนนิ้วบนแถบเลือกความเร็ว ใน โหมด Pulse คุณสามารถปรับส่วนผสมแบบรวดเร็วจนได้ความละเอียดที่ต้องการ กดโอบคอน Pulse เพื่อไปยังโหมด Pulse และโอบคอนระดับความเร็วจะเริ่มกะพริบ กดปุ่ม 1 หรือ 5 เพื่อพัลส์ด้วยความเร็วระดับที่ต้องการ กดโอบคอนสัญลักษณ์โทรศัพท์มือถือหากต้องการใช้งานโปรแกรมหจากแอป

การตั้งค่า / โปรแกรมที่แนะนำสำหรับโอบนผสม - สมูทตี้, ซุป, น้ำแข็งบด, ความเร็ว (1-5), โหมด Pulse

การตั้งค่า / โปรแกรมที่แนะนำโอบสับ และโอบด - ความเร็ว (1-5), โหมด Pulse

ข้อสำคัญ! เครื่องปั่นผสมของคุณพร้อมกับระบบนรีกยสองชั้น เครื่องปั่นจะไม่เริ่มการทำงานและส่วนแสดงผลจะกะพริบเพื่อเตือนว่าฝาปิดหรือโอบอยู่ในตำแหน่งที่ไม่ถูกต้อง ทั้งนี้เพื่อป้องกันไม่ให้เกิดอุบัติเหตุที่สกปรกและอะไหล่ของคร้วของคุณ

คำเตือน! ห้ามถอดถ้วยดวงหรือฝาออกระหว่างปั่นส่วนผสม ห้ามเปิดเครื่องปั่นเปล่า ๆ เพราะอาจทำให้เครื่องปั่นร้อนเกินไปและเสียหายได้ เก็บจานซามซอสน้อมและมีือให้ห่างจากโอบนผสมระหว่างการใช้งาน

8 การหยุดการทำงาน - เครื่องปั่นจะทำงานจนกว่าจะจบโปรแกรม หากต้องการหยุดโปรแกรมหด้วยตัวเอง ให้กดโอบคอนหยุด

9 การทำความสะอาดหลังใช้งาน – เราแนะนำให้ล้างส่วนประกอบทันทีหลังใช้งานเสร็จเพื่อป้องกันไม่ให้เศษอาหารแห้งติดอยู่บนส่วนผสม

ข้อสำคัญ! เพื่อป้องกันไม่ให้โอบแตกร้าว ควรล้างโอบด้วยน้ำสะอาดทันทีหลังจากใช้งานเสร็จ เพื่อป้องกันไม่ให้กรดหรือน้ำมันทำให้อายุการใช้งานของพลาสติกเปลี่ยนสี ล้างโอบให้สะอาดเสมอก่อนจะนำไปวางในเครื่องล้างจาน เติมน้ำอุ่นลงในโอบ จากนั้นปิดฝา แล้ววางโอบลงบนตัวเครื่อง

10 ความเร็วสำหรับทำความสะอาด - ใช้ความเร็วระดับ 5 เป็นเวลา 30 วินาทีสำหรับการทำความสะอาดโอบนผสมและโอบด ส่วนโอบสับ ควรใช้ความเร็วระดับ 1

11 ถอดปลั๊กออก

การทำความสะอาดและการดูแลรักษา

การทำความสะอาดตัวเครื่องและอินเทอร์เฟซอย่างหมดจด - ปิดเครื่องปั่นแล้วถอดปลั๊กออก เช็ดทำความสะอาดฐานเครื่องปั่นด้วยผ้าชุบน้ำหมาด ๆ

คำเตือน! ห้ามจุ่มตัวเครื่อง ปลั๊ก หรือสายไฟในน้ำหรือของเหลวใด ๆ

การทำความสะอาดโอบอย่างหมดจด - ถอดส่วนประกอบทั้งหมดออก ล้างใบมีดในน้ำและน้ำยาล้างจาน หมายเหตุ!

ชุดใบมีดของโอบนถอดออกไม่ได้ คำเตือน! จับอย่างระวังเพราะใบมีดคมมาก!

ขอให้มีความสุขกับผลิตภัณฑ์ Electrolux เครื่องใหม่!

การทิ้ง



เมื่อมีสัญลักษณ์บนผลิตภัณฑ์หรือบนบรรจุภัณฑ์ แสดงว่าอาจจะไม่สามารถกำจัดผลิตภัณฑ์เป็นขยะครัวเรือนได้ ในการรีไซเคิลผลิตภัณฑ์ แนะนำให้นำผลิตภัณฑ์ไปยังจุดเก็บรวบรวมอย่างเป็นทางการหรือศูนย์บริการของ Electrolux ซึ่งสามารถถอดแบตเตอรี่และชิ้นส่วน ไฟฟ้าออกมารีไซเคิลได้อย่างปลอดภัยอย่างมีอาชีพ นอกจากนี้แล้ว ควรปฏิบัติตามกฎระเบียบของประเทศในการแยกขยะที่เป็นผลิตภัณฑ์เครื่องใช้ไฟฟ้าและแบตเตอรี่แบบชาร์จใหม่ได้

Electrolux ขอสงวนสิทธิ์ในการเปลี่ยนผลิตภัณฑ์ ข้อมูล และข้อมูลจำเพาะของผลิตภัณฑ์โดยไม่ต้องแจ้งให้ทราบ

การดูแลและการให้บริการลูกค้า

เมื่อติดต่อฝ่ายบริการ คุณต้องเตรียมข้อมูลต่อไปนี้ไว้ให้พร้อม: รุ่น, PNC, หมายเลขเครื่อง โดยดูข้อมูลเหล่านี้ได้จากแผ่นป้ายระบุ

เนื่องจาก Electrolux มีนโยบายที่จะพัฒนาผลิตภัณฑ์อย่างต่อเนื่อง ส่วนของข้อมูลจำเพาะ สีและรายละเอียดของผลิตภัณฑ์ และที่ปรากฏในคู่มือนี้อาจเปลี่ยนแปลงได้โดยไม่ต้องแจ้งให้ทราบ



สูตร

ขอแนะนำให้เชื่อมต่อกับแอป Master X เพื่อใช้ประโยชน์สูงสุดจากเครื่องปั่นผสม ภายในแอปมีโปรแกรมสูตรอาหารแบบเร่งด่วนมากกว่า 25 โปรแกรม และสูตรอาหารอย่างละเอียดอีกกว่า 15 สูตร ซึ่งจะมอบแรงบันดาลใจให้กับการทำอาหารของคุณในทุก ๆ วัน

ตารางด้านล่างคือแนวทางทั่วไปสำหรับสูตรอาหารสำหรับเครื่องปั่นผสม Master 9

เวลาเตรียมอาหารสูงสุด	ความจุสูงสุด
2 นาที	1500 มล.

ความเร็วในการผสมที่แนะนำ*					
สูตร	ส่วนผสม	ปริมาณ		เวลา	ความเร็ว
ผักสดปั่น	แครอท	20-160	กรัม	30 วินาที	5 (ความเร็วสูงสุด)
	มันฝรั่ง	20-160	กรัม		
	หัวหอมใหญ่	20-160	กรัม		
	น้ำ	40-320	กรัม		
สมูทตี้สับปะรด-แอปเปิ้ลคอต	สับปะรดหั่นแว่น	250	กรัม	≤ 120 วินาที	
	แอปเปิ้ลคอตแห้ง	40	กรัม		
	โยเกิร์ต	300	กรัม		
ชุป	แครอท	600	กรัม	≤ 60 วินาที	5 (ความเร็วสูงสุด)
	น้ำ	900	มล.		
ราสเบอร์รี่สมูทตี้	ราสเบอร์รี่แช่แข็ง	250	กรัม	≤ 60 วินาที	
	กล้วย (½ ชิ้น)	50	กรัม		
	น้ำ	50	กรัม		
	โยเกิร์ต	300	กรัม		
มิลค์เชค	นม	150-300	มล.	15-30 วินาที	
	ไอศกรีมวานิลลา	150-300	มล.		
	กล้วย	¼ - ½	ชิ้น		
	น้ำเชื่อมช็อกโกแลต	30-60	กรัม		

ความเร็วในการผสมที่แนะนำ*					
สูตร	ส่วนผสม	ปริมาณ		เวลา	ความเร็ว
ซูปมันฝรั่งกับต้นลิค	มันฝรั่ง	200	กรัม	60 วินาที	
	ต้นลิค	200	กรัม		
	น้ำ	600	กรัม		
แพนเค้ก (แป้ง)	แป้งสาลี 1	150	กรัม	30~40 วินาที	
	เกลือ	1	หยิบมือ		
	ไข่	3	ชิ้น		
	นม	250	มล.		
	น้ำ	140	มล.		
	เนย	50	กรัม		

การแก้ไขปัญหา

รายการ	ลักษณะอาการ	สาเหตุ	วิธีแก้ไขปัญหา	สัญญาณบ่งชี้
1	เครื่องปั่นไม่เริ่มทำงาน	ไม่ได้กดปุ่มเปิด/ปิด	ตรวจสอบให้ UI อยู่ในโหมด ON_IDLE ถ้าไม่ได้อยู่ในโหมดนี้ ให้หัดกดปุ่มเปิด/ปิดเพื่อเปิดเครื่องปั่น	ไฟ LED แสดงสถานะไม่สว่างขึ้น
		a. ติดตั้งโถอย่างไม่ต้องหรือโถยังไม่ล็อกเข้าที่ก่อนจะเริ่มใช้โปรแกรม โหมด Pulse หรือเลือกความเร็ว	ติดตั้งและล็อกโถให้เข้าที่ a. เริ่มใช้งานโปรแกรม/ความเร็วที่เลือกอีกครั้ง โดยการกดปุ่มที่ต้องการ	a. ไฟ LED ทุกดวง (ยกเว้น Wi-Fi) เริ่มกะพริบเป็นเวลา 3 วินาที จากนั้นจึงเข้าสู่โหมด ON_IDLE
		b. ติดตั้งโถอย่างไม่ต้องหรือโถยังไม่ล็อกเข้าที่หลังจากหยุดโปรแกรมชั่วคราว	ปิดปุ่มที่กะพริบเพื่อสั่งให้โปรแกรมทำงานต่อ	a. ไฟ LED ทุกดวง (ยกเว้น Wi-Fi) เริ่มกะพริบเป็นเวลา 3 วินาที จากนั้นจึงกลับเข้าสู่สถานะ PAUSED
		a. ไม่ได้ปิดฝาหรือฝาอยู่ในตำแหน่งไม่ถูกต้องก่อนจะเริ่มใช้โปรแกรม โหมด Pulse หรือเลือกความเร็ว	ปิดฝาหรือปรับตำแหน่งของฝาปิดให้เข้าที่ a. เริ่มใช้งานโปรแกรม/ความเร็วที่เลือกอีกครั้ง โดยการกดปุ่มที่ต้องการ	b. ไฟ LED ทุกดวง (ยกเว้น Wi-Fi) เริ่มกะพริบเป็นเวลา 3 วินาที
		b. ไม่ได้ปิดฝาหรือฝาอยู่ในตำแหน่งไม่ถูกต้องหลังจากหยุดโปรแกรมชั่วคราว	b. กดปุ่มที่กะพริบเพื่อสั่งให้โปรแกรมทำงานต่อ	
		มอเตอร์ร้อนเกินไป	ปิดการทำงานของเครื่องปั่น ถอดปลั๊กออก รอ 10 นาทีให้มอเตอร์เย็นลงก่อนจะเปิดใช้งานเครื่องปั่นอีกครั้ง	เครื่องปั่นไม่ทำงานและไฟ LED แสดงสถานะไม่สว่างขึ้น
		ไม่ได้เสียบปลั๊กอย่างถูกต้องหรือไม่มีการจ่ายไฟจากเต้ารับ	ตรวจสอบว่าเสียบปลั๊กดีหรือไม่ หรือลองเสียบกับเต้ารับอื่น	ไฟ LED แสดงสถานะไม่สว่างขึ้น
		ไฟดับ	รอกันกว่าไฟจะมา แล้วจึงค่อยใช้งานเครื่องปั่น	ไฟ LED แสดงสถานะไม่สว่างขึ้น
ไม่สามารถใช้งานเครื่องปั่นได้ในโหมด APP_Mode	เครื่องปั่นไม่ได้เชื่อมต่อกับเครือข่าย ตรวจสอบการเชื่อมต่อแบบไร้สายกับเครื่องปั่น	แอปหาเครื่องปั่นไม่เจอ		
เครื่องปั่นไม่ทำงาน	กรุณาติดต่อขอความช่วยเหลือจากศูนย์บริการใกล้บ้าน	เครื่องปั่นไม่ทำงานหลังจากแก้ไขอาการผิดพลาดแล้ว		

รายการ	ลักษณะอาการ	สาเหตุ	วิธีแก้ไขปัญหา	สัญญาณบ่งชี้
2	มอเตอร์หยุดทำงานระหว่างเตรียมอาหาร	มีการถอดโถหรือฝาปิดระหว่างที่เครื่องปั่นทำงาน	ควรติดตั้งโถหรือฝาปิดไว้เสมอระหว่างการใช้งาน ตั้งโถและฝาปิดให้ถูกต้องก่อนจะเริ่มใช้งานต่อไป	มอเตอร์หยุดทำงาน a. ไฟ LED ทุกดวงเริ่มกะพริบเป็นเวลา 3 วินาที จากนั้นจึงเข้าสู่โหมด ON_IDLE B. UI ยังคงอยู่ในสถานะ PAUSED
		การป้องกันไม่ให้เครื่องปั่นร้อนเกินไป	หากมอเตอร์ดับกลางคัน ให้ปิดเครื่องปั่นทันที จากนั้นถอดปลั๊กออก แล้วปล่อยให้เย็นอย่างน้อย 10 นาทีก่อนจะเสียบปลั๊กแล้วเปิดใช้งานอีกครั้ง	เครื่องปั่นทำงานและไฟ LED แสดงสถานะไม่สว่างขึ้น
		ส่วนผสมชิ้นใหญ่เกินไป	ตัดแบ่งส่วนผสมเป็นชิ้นเล็ก ๆ ถอดปลั๊กอย่างน้อย 10 วินาทีแล้วเสียบปลั๊กอีกครั้งเพื่อเปิดใช้งานเครื่องปั่นต่อไป	เครื่องปั่นทำงานและไฟ LED แสดงสถานะไม่สว่างขึ้น
		การใช้โถ/อุปกรณ์เสริมอย่างไม่ถูกต้องหรือใส่ส่วนผสมที่ไม่เหมาะสม	ควรใช้โถและอุปกรณ์เสริมให้เหมาะสมกับส่วนผสม (โถใช้สำหรับปั่นผสมผักและผลไม้)	เครื่องปั่นทำงานและไฟ LED แสดงสถานะไม่สว่างขึ้น
		เปิดการตั้งเวลาหยุดทำงานเพื่อป้องกันไม่ให้เครื่องร้อนเกินไป	กดปุ่มที่ต้องการเพื่อใช้งานต่อ	เครื่องปั่นทำงานด้วยความเร็ว โหมด Pulse หรือโปรแกรมเดี่ยวต่อเนื่องกันเป็นเวลา 3 นาทีแล้วหยุดทำงาน ไฟ LED ทุกดวง (ยกเว้น Wi-Fi เริ่มกะพริบเป็นเวลา 3 วินาที จากนั้นจึงเข้าสู่โหมด ON_IDLE)
3	อาหารรั่วไหลออกจากโถบิด	การถอดโถออกจากตัวเครื่องโดยการหมุนโถแกวแทนที่จะหมุนฐานประกอบชุดใบมีดโถบิดทวนเข็มนาฬิกา อาจจะทำให้โถแกวหลวมและอาหารรั่วไหลออกมาได้	วางโถแกวลงบนฐานประกอบชุดใบมีดโถบิดแล้วหมุนตามทิศทางของเข็มนาฬิกาจนแน่นหนา ก่อนจะนำมาติดตั้งเข้ากับตัวเครื่อง เมื่อจะถอดออกจากตัวเครื่อง ให้หมุนตรงฐานประกอบชุดใบมีดโถบิดทวนทิศทางของเข็มนาฬิกาเท่านั้น	อาหารรั่วไหลออกจากโถแกวตอนถอดโถแกวออกจากตัวเครื่อง
4	โถสับไม่ทำงานเมื่อติดตั้งเข้ากับตัวเครื่อง	ไม่ได้ประกอบกระปุกเกียร์ของโถสับเข้ากับโถสับ	ประกอบกระปุกเกียร์ของโถสับก่อน ตามด้วยใบมีดสำหรับโถสับ	เมื่อกดไอคอน ไฟ LED ทั้งหมดกะพริบเป็นเวลา 3 วินาที และโถสับไม่เริ่มทำงาน

รายการ	ลักษณะอาการ	สาเหตุ	วิธีแก้ไขปัญหา	สัญญาณบ่งชี้
5	การลงทะเบียนและการเข้าสู่ระบบบัญชีของแอป	สร้างบัญชีไม่ได้	เคยมีการสร้างบัญชีด้วยอีเมลนี้แล้ว กรุณาใช้อีเมลอื่นมาสร้างบัญชีใหม่ หรือใช้อีเมลนี้ในการตั้งรหัสผ่านใหม่สำหรับบัญชีที่มีอยู่	คุณได้รับข้อความต่อไปนี้เมื่อลงทะเบียนเปิดบัญชีใหม่ "เราได้ส่งอีเมลไปให้คุณริเชตริรหัสผ่านแล้ว"
		a. ข้อผิดพลาดเกี่ยวกับรหัสผ่าน b. ไม่มีบัญชีนี้อยู่	a. คลิก "ลืมรหัสผ่าน" เพื่อขอรับอีเมลสำหรับตั้งรหัสผ่าน b. คลิก "ไม่มีบัญชี?" เพื่อสร้างบัญชีใหม่	คุณได้รับข้อความต่อไปนี้เมื่อพยายามจะเข้าสู่ระบบ "ชื่อผู้ใช้หรือรหัสผ่านไม่ถูกต้อง"
6	การลงทะเบียนอุปกรณ์	ไม่สามารถเชื่อมต่อกับ SSID WIFI ที่ต้องการ	บ่อนรหัสผ่าน WIFI ตั้งค่าเราท์เตอร์ให้สามารถเชื่อมต่อกับเครื่องบินผ่าน WIFI ได้ (โปรดปรึกษาผู้ผลิตเราท์เตอร์เพื่อขอความช่วยเหลือในการตั้งค่า)	การตั้งค่าล้มเหลว
		เครื่องหา SSID ไม่เจอ	WIFI ของเราท์เตอร์ต้องกระจายสัญญาณสัญญาณ SSID เครือข่าย ความถี่ 2.4 GHZ ไม่สามารถซ่อนการตั้งค่า SSID ในเราท์เตอร์ได้ (โปรดปรึกษาผู้ผลิตเราท์เตอร์เพื่อขอความช่วยเหลือในการตั้งค่า)	มองไม่เห็น SSID ของเราท์เตอร์ในแอประหว่างลงทะเบียนอุปกรณ์
		ระหว่างการเชื่อมต่อเครื่องบิน สัญญาณ WIFI บนโทรศัพท์กะพริบไม่หยุด การตั้งค่าล้มเหลวหลังจากพยายามเชื่อมต่อสัญญาณ	เปิด GPS บนโทรศัพท์ แล้วลองเชื่อมต่อเครื่องบินในระหว่างการลงทะเบียนอุปกรณ์อีกครั้ง	ต้องเปิดใช้งาน GPS บนโทรศัพท์เพื่อตรวจหา AP เครื่องบิน จำเป็นต้องทำขั้นตอนนี้ในการลงทะเบียนอุปกรณ์เท่านั้น
7	ข้อผิดพลาดในแอปโทรศัพท์มือถือ	เครื่องบินไม่ได้เชื่อมต่อสัญญาณ WIFI	ดูคู่มือการใช้งานเราท์เตอร์เพื่อกำหนดระยะห่างที่เหมาะสมที่สุดและตรวจสอบสิ่งกีดขวางรบกวนสัญญาณ วางเครื่องบินให้ใกล้กับเราท์เตอร์มากที่สุดเพื่อป้องกันสัญญาณ WIFI หาย	ไม่มีสัญลักษณ์ WIFI และไม่มีการเชื่อมต่อกับเครือข่าย WIFI
		ไม่ได้เปิดเครื่องบิน	กดปุ่มเปิดที่ด้านข้างเครื่องบิน รอให้สัญลักษณ์ WIFI ปรากฏ จากนั้นจึงส่งการตั้งค่าจากแอปโทรศัพท์มือถือ	เกิดข้อผิดพลาดในแอปโทรศัพท์มือถือเมื่อส่งการตั้งค่าไปยังเครื่องบิน

SÁCH HƯỚNG DẪN

- Các biểu tượng đồ họa và bản vẽ trong sách hướng dẫn này chỉ nhằm mục đích minh họa và có thể thay đổi theo sản phẩm thực tế
- Đọc kỹ các hướng dẫn sau trước khi sử dụng thiết bị lần đầu.
- Giữ lại các hướng dẫn này để tham khảo về sau.

CẤU TẠO

- | | |
|---|--|
| <ul style="list-style-type: none"> A. Cốc Đong (có thể rửa bằng máy rửa bát) B. Nắp máy xay có lỗ lọc (có thể rửa bằng máy rửa bát) C. Vòi D. Cối xay (Cối xay với lưỡi dao không thể tháo rời (có thể rửa bằng máy rửa bát)?) E. Tay cầm F. Bộ Phận Đế G. Nút on/off (bật/tắt) H1. Chương trình sinh tố (Biểu tượng Sinh tố?) H2. Chương trình súp (Biểu tượng Súp?) H3. Chương trình nghiền đá (Biểu tượng Nghiền đá?) H4. Bắt đầu công thức từ Ứng Dụng (Biểu tượng Bắt đầu công thức từ Ứng Dụng?) H5. Chương trình dừng (Biểu tượng Dừng?) H6. Tốc độ 1-5 (Biểu tượng Tốc độ 1- 5?) H7. Chương trình xung (Biểu tượng Xung?) H8. Biểu tượng đã kết nối Wifi | <ul style="list-style-type: none"> I1. Nắp máy băm* (có thể rửa bằng máy rửa bát) I2. Lưỡi băm* (có thể rửa bằng máy rửa bát) I3. Hộp số máy băm* I4. Cối băm* (có thể rửa bằng máy rửa bát) J1. Cối nghiền* (có thể rửa bằng máy rửa bát) J2. Lưỡi máy nghiền* J3. Giá đỡ để lắp lưỡi máy nghiền* (có thể rửa bằng máy rửa bát) <p>*Chỉ một số mẫu nhất định
Hình minh họa trang 3-5</p> |
|---|--|

LỜI KHUYÊN VỀ AN TOÀN

- Loại bỏ và xử lý an toàn bất kỳ vật liệu bao bì nào trước khi sử dụng thiết bị.
- Không cho phép những người (bao gồm cả trẻ em) bị suy giảm năng lực thể chất, trí tuệ hoặc cảm giác, hay người thiếu kinh nghiệm và kiến thức sử dụng thiết bị này, trừ khi có sự giám sát hoặc hướng dẫn của người chịu trách nhiệm về vấn đề an toàn của họ.
- Giữ thiết bị và dây điện ngoài tầm tay trẻ em. Trẻ em phải được giám sát để đảm bảo chúng không nghịch phá thiết bị này.
- Không để trẻ em vệ sinh và bảo trì thiết bị khi không có người giám sát.
- Chỉ được cắm thiết bị vào nguồn điện có điện áp và tần số tuân thủ các thông số kỹ thuật trên biển thông số.
- Không bao giờ được sử dụng hoặc nhắc thiết bị lên nếu dây điện bị hỏng và/hoặc vỏ máy bị hỏng.
- Thiết bị hoặc dây nguồn bị hỏng phải được thay bởi Electrolux hoặc đại lý bảo dưỡng của Electrolux để tránh nguy hiểm.
-  Không ngâm thiết bị, dây nguồn hoặc phích cắm của thiết bị trong nước hoặc bất kỳ chất lỏng nào.
- Không sử dụng hoặc đặt thiết bị gần bếp, nguồn khí nóng, lò sưởi, bếp điện hoặc lò đun nóng.
- Luôn đặt thiết bị trên bề mặt nhẵn, phẳng và khô.
- Luôn ngắt kết nối thiết bị với nguồn điện nếu không có ai chú ý đến thiết bị và trước khi thay phụ kiện, vệ sinh hoặc bảo trì.
- Các lưỡi dao và các phụ kiện lắp thêm rất sắc. Nguy hiểm có thể gây thương tích. Cẩn thận khi thay phụ kiện, sau khi sử dụng và trong quá trình làm sạch và bảo trì.

- Không bao giờ dùng tay hoặc các vật nào khác để chạm vào lưỡi dao hoặc các phụ kiện lắp thêm trong khi máy đang được cắm điện và/hoặc trong quá trình vận hành.
- Không cố tháo lắp bộ lưỡi cắt.
- Giữ tay và dụng cụ tránh xa thiết bị trong quá trình vận hành để tránh nguy cơ bị thương nặng cho người hoặc gây hư hỏng thiết bị.
- Đảm bảo rằng thiết bị đã được tắt trước khi lấy bình ra khỏi chân máy có gắn động cơ.
- Không vận hành thiết bị khi không có thức ăn hoặc chất lỏng trong bình.
- Không bao giờ sử dụng máy mà không đậy nắp.
- Không sử dụng thiết bị liên tục trong vòng hơn 2 phút khi chế biến khối lượng lớn. Sau 2 phút liên tục sử dụng với khối lượng lớn, thiết bị nên được để nguội trong vòng ít nhất 5 phút trước khi khởi động lại.
- Không được dùng bình để trộn hoặc nghiền các chất cứng và khô, trừ đá viên. Sử dụng lưỡi xay đa năng để nghiền các chất cứng và khô (ví dụ: hạt, kẹo, gạo ...)
- Cẩn thận khi đổ chất lỏng nóng vào thiết bị vì chất lỏng có thể bị trào ra khỏi thiết bị do đột ngột hấp hơi.
- Không bao giờ thao tác với chất lỏng đun sôi (tối đa 90°C).
- Không cho nguyên liệu vượt quá thể tích tối đa cho phép theo chỉ dẫn trên thiết bị.
- Không sử dụng thiết bị này để khuấy sơn. Nguy hiểm, có thể gây nổi!
- Không để dây nguồn tiếp xúc với các bề mặt nóng hoặc vắt lên cạnh bàn hoặc kệ bếp.
- Tuyệt đối không sử dụng các phụ kiện hoặc bộ phận của các nhà sản xuất khác mà Electrolux không khuyến nghị hoặc bán vì việc này có thể dẫn đến nguy cơ gây thương tích cho mọi người.
- Chỉ sử dụng thiết bị này trong nhà.
- Thiết bị này chỉ để sử dụng trong gia đình. Electrolux sẽ không chịu bất kỳ trách nhiệm pháp lý nào về hư hỏng có thể xảy ra do sử dụng không đúng cách hoặc sai mục đích.
- Thiết bị này phù hợp để vận hành trên cả 50 lần 60Hz.
- LƯU Ý: Để tránh nguy hiểm do vô tình cài đặt lại bộ phận ngắt nhiệt, không được lắp thêm thiết bị chuyển mạch bên ngoài, chẳng hạn như thiết bị hẹn giờ hoặc kết nối với một mạch điện thường xuyên được bật tắt.

LÀM QUEN

Trước khi sử dụng thiết bị lần đầu tiên, hãy gỡ bỏ tất cả những vật liệu đóng gói như nhựa, nhãn dán hoặc thẻ có thể dính kèm với các bộ phận. Lau sạch thiết bị và phụ kiện, xem hướng dẫn: "Làm Sạch và Chăm Sóc".

Luôn luôn chuẩn bị sẵn nguyên liệu: Rửa sạch thật kỹ và cắt làm 4 đến 6 phần và loại bỏ tất cả những hạt lớn hoặc cứng. Gọt bỏ lớp vỏ dày của rau củ hoặc hoa quả.

SỬ DỤNG SẢN PHẨM

1 **Làm sạch** - Đảm bảo quý vị sử dụng một chiếc cốc sạch, rửa sạch cốc trước khi sử dụng.

2 **Cắm vào nguồn điện**

3 **Công suất tối đa**

Máy Xay - Quý vị có thể xay tối đa 1.5L nguyên liệu với máy xay, để tránh nguyên liệu bị bắn ra ngoài. **CẢNH BÁO!** Chúng tôi đề nghị để nguội chất lỏng nóng (tối đa 90 °C) trước khi đổ vào cối. Chỉ rút dây nửa cối và bắt đầu xay với tốc độ thấp. Cối máy xay có thể trở nên rất ấm, hãy vận hành một cách cẩn thận để bảo vệ tay của quý vị và để hơi thoát ra ngoài qua lỗ phụ.

Máy Băm - Quý vị có thể băm tối đa 0.4L nguyên liệu với máy băm, để tránh nguyên liệu bị bắn ra ngoài.

Máy Nghiền - Quý vị có thể nghiền tối đa 0.4L nguyên liệu với máy nghiền, để tránh nguyên liệu bị bắn ra ngoài.

4 Lắp ráp cối

Máy Xay - Đặt nắp lên cối , đảm bảo nắp được gắn chặt. Gắn cốc đong vào nắp bằng cách xoay theo chiều kim đồng hồ cho đến khi nó khớp vào vị trí. Quý vị có thể thêm nguyên liệu qua lỗ phụ khi máy xay không hoạt động.

Máy Băm - Gắn hộp số máy băm vào dưới cối băm và xoay theo chiều kim đồng hồ cho đến khi nó khớp vào vị trí. Đặt lưỡi máy băm lên trên trụ trong cối băm và đẩy lưỡi băm xuống vị trí. Đặt nắp máy băm lên trên cối và xoay theo chiều kim đồng hồ cho đến khi nó khớp vào vị trí.

Máy Nghiền - Đặt cối nghiền với đầu mở xoay lên trên, và cho nguyên liệu vào trong. Đẩy lưỡi nghiền giữa lên trong giá đỡ để lắp lưỡi máy nghiền cho đến khi nó cố định. Lật ngược giá đỡ để lắp lưỡi, và lắp vào cối cho đến khi nó được gắn chặt. Lật ngược máy với nguyên liệu bên trong.

5 Đặt cối xay vào bộ phận đế

Máy xay và máy băm - Đặt cối lên bộ phận đế với tay cầm bên phải. Xoay theo chiều kim đồng hồ cho đến khi nó khớp vào vị trí. (Cối chỉ có thể được đặt vào một vị trí, tay cầm hướng về phía quý vị. Cho nguyên liệu vào trong cối.

Máy nghiền - Giữ giá đỡ để lắp lưỡi máy nghiền và đặt máy nghiền đã được lắp ráp vào bộ phận đế . Xoay theo chiều kim đồng hồ cho đến khi nó khớp vào vị trí. Cối chỉ có thể đặt vào một vị trí, đảm bảo biểu tượng khóa trên giá đỡ để lắp lưỡi hướng về phía quý vị khi lắp cối.

6 Khởi động máy xay - Ấn nút ON/OFF (BẬT/TẮT). Các biểu tượng sẽ phát sáng trên màn hiển thị. Các nút sẽ sáng đèn trên màn hiển thị.**7 Chọn tốc độ hoặc chương trình phù hợp**

You have preset speeds 1-5, dedicated recipe programs- smoothie, Soup, Ice crush (H), and Pulse mode to choose from. The selected speed or recipe program will light up. You can activate any speed by tapping on the speed setting and adjust the speed either by tapping a different speed, or sliding your fingers on the speed bar. With Pulse mode you can give the ingredients a quick mix to achieve your desired consistency. Press the Pulse icon to go into Pulse mode. The Pulse and the speed icons start blinking. Press 1 to 5 to pulse at different speeds. Press the Start recipe from App icon if you would like to perform the program received from the app.

Quý vị có tốc độ cài sẵn 1-5, chương trình công thức chuyên biệt- sinh tố , Súp , Đá nghiền , và chế độ Xung để chọn. Tốc độ hoặc chương trình công thức được chọn sẽ sáng đèn. Quý vị có thể kích hoạt bất kì tốc độ nào bằng việc nhấn vào cài đặt tốc độ và điều chỉnh tốc độ bằng cách nhấn một tốc độ khác, hoặc trượt ngón tay trên thanh tốc độ .Với Chế độ xung quý vị có thể trộn nhanh nguyên liệu để đạt được độ nhất quán mong muốn. Ấn biểu tượng Pulse (Xung) để sử dụng chế độ Xung. Biểu tượng Xung và tốc độ bắt đầu nhấp nháy. Ấn từ 1 đến 5 để chạy xung ở các tốc độ khác nhau. Ấn công thức Bắt Đầu từ biểu tượng App (Ứng Dụng) nếu quý vị muốn chạy chương trình nhận được từ ứng dụng.

Các chương trình/cài đặt đề xuất cho Máy Xay - sinh tố , Súp , Đá nghiền , Tốc Độ (1-5), chế độ Xung

Các chương trình/cài đặt đề xuất cho Máy Băm và Máy Nghiền- Tốc Độ (1-5), chế độ Xung

QUAN TRỌNG! Máy xay của quý vị được trang bị với hệ thống an toàn kép. Sản phẩm sẽ không bắt đầu hoạt động và hiển thị sẽ nháy sáng chỉ báo rằng nắp hoặc cối không được đặt đúng vị trí. Điều này đảm bảo quý vị không gặp phải tai nạn không mong muốn trong bếp.

CẢNH BÁO! Không bao giờ được bỏ cốc đong hoặc nắp khi đang sử dụng sản phẩm. Không bao giờ sử dụng máy xay mà không có nguyên liệu, việc sử dụng máy xay trống có thể gây quá nhiệt và tổn hại đến sản phẩm. Để tay và các dụng cụ tránh ra cối xay khi đang xay.

8 Stopping the product - The blender will operate until the program is finished. To stop any program manually, press the Stop icon.

Ngừng sản phẩm - Máy xay sẽ hoạt động cho đến khi kết thúc chương trình. Để ngừng bất kì chương trình nào thủ công, ấn biểu tượng Stop (Ngừng).

9 Làm sạch sau khi sử dụng - Chúng tôi khuyên quý vị nên rửa các bộ phận ngay sau khi sử dụng để tránh việc thức ăn thừa bị khô dính trên các bộ phận.

QUAN TRỌNG! Để tránh làm rạn nứt cối, luôn luôn rửa sạch cối trực tiếp với nước sạch sau khi sử dụng để tránh axit hoặc dầu mỡ tẩy màu vật liệu nhựa. Đổ nước ấm vào cối, đẩy nắp và đặt cối lên bộ phận đế.

10 Tốc độ làm sạch - Chạy tốc độ 5 trong 30 giây trên Máy Xay và Máy Nghiền, chạy tốc độ 1 cho máy băm).

11 Rút phích cắm thiết bị

VỆ SINH VÀ CHĂM SÓC

Vệ sinh kỹ lưỡng bộ phận đế và bề mặt - Tắt máy xay và rút dây nguồn. Lau sạch đế máy xay bằng khăn ẩm. CẢNH BÁO! Không nhúng bộ phận đế, phích cắm hoặc dây trong nước hoặc bất kỳ chất lỏng nào khác.

Vệ sinh kỹ lưỡng các cối – Tháo tất cả các bộ phận. Làm sạch các lưỡi dao bằng nước và chất tẩy rửa. Lưu ý! Lưỡi dao của Máy Xay không thể tháo rời. CẢNH BÁO! Xử lý thật cẩn thận, các lưỡi dao rất sắc!

Hãy trải nghiệm sản phẩm Electrolux mới của quý vị!

TIÊU HỦY



Biểu tượng này trên sản phẩm hoặc trên bao bì sản phẩm cho biết rằng sản phẩm không thể được xử lý như chất thải gia dụng. Để tái chế sản phẩm của quý vị, vui lòng mang sản phẩm đến điểm thu gom chính thức hoặc đến trung tâm dịch vụ Electrolux, nơi có thể tháo và tái chế pin và các bộ phận điện một cách an toàn và chuyên nghiệp. Thực hiện theo quy định của quốc gia quý vị đối với việc thu gom riêng các sản phẩm điện và pin có thể sạc.

Electrolux bảo lưu quyền thay đổi sản phẩm, thông tin và thông số kỹ thuật mà không cần thông báo trước.

BỘ PHẬN CHĂM SÓC VÀ DỊCH VỤ KHÁCH HÀNG

Khi liên lạc với Bộ Phận Dịch Vụ, hãy đảm bảo rằng quý vị có sẵn các dữ liệu sau đây: **Model, PNC, Số Sê-ri**. Các thông tin này có thể được tìm thấy trên biển thông số.





Theo chính sách phát triển sản phẩm liên tục của Electrolux; các thông số kỹ thuật, màu sắc, và các chi tiết sản phẩm của chúng tôi và những gì được đề cập trong sổ tay hướng dẫn này có thể thay đổi mà không cần thông báo.

CÁC CÔNG THỨC PHA CHẾ

Đảm bảo rằng thiết bị của quý vị được kết nối với Ứng Dụng Master X để quý vị có thể tận dụng hết khả năng của chiếc máy xay. Có hơn 25 Chương Trình Công Thức Nhanh & hơn 15 Công Thức Từng Bước có thể truyền cảm hứng cho việc nấu ăn của quý vị mỗi ngày.

Bảng bên dưới là hướng dẫn chung Công Thức Máy Xay Master 9.

THỜI GIAN XAY TỐI ĐA	CÔNG SUẤT TỐI ĐA
2 phút	1500 ml

VẬN TỐC XAY ĐỀ XUẤT					
Công thức	Nguyên liệu	Số lượng		Thời gian	Tốc độ
Rau quả tươi dạng sệt (puree)	Cà rốt	20~160	g	30 s	5 (Tốc độ tối đa)
	Khoai tây	20~160	g		
	Hành củ	20~160	g		
	Nước	40~320	g		
Smoothie Dứa-mơ	Dứa cắt lát	250	g	≤ 120 s	
	Quả mơ khô	40	g		
	Sữa chua	300	g		
Súp	Cà rốt	600	g	≤ 60 s	5 (Tốc độ tối đa)
	Nước	900	ml		
Smoothie Mâm xôi	Quả mâm xôi đông lạnh	250	g	≤60 s	
	Chuối (½ quả)	50	g		
	Nước	50	g		
	Sữa chua	300	g		
Sữa lắc (milkshake)	Sữa	150-300	ml	15~30 s	
	Kem vani	150-300	ml		
	Chuối	¼ - ½	quả		
	Si-rô sô-cô-la	30-60	g		
Súp Khoai tây Tỏi tây	Khoai tây	200	g	60 s	
	Tỏi tây	200	g		
	Nước	600	g		
Bánh Pancake (bột nhão)	Bột mì 1	150	g	30~40 s	
	Muối	1	nhúm		
	Trứng	3	quả		
	Sữa	250	ml		
	Nước	140	ml		
	Bơ	50	g		

XỬ LÝ SỰ CỐ

MỤC	DẤU HIỆU	NGUYÊN NHÂN	GIẢI PHÁP	CHỈ BÁO
1	Máy Xay không Khởi Động	Nút ON/OFF (BẬT/TẮT) chưa được nhấn	Đảm bảo giao diện người dùng (UI) ở chế độ ON_IDLE (CHỜ). Nếu không, nhấn nút ON/OFF (BẬT/TẮT) để bật máy xay	Không có chỉ báo đèn LED nào sáng
		a. Bình được lắp không chính xác hoặc không được cố định trước khi bắt đầu chương trình, xung hoặc lựa chọn tốc độ	Lắp và khóa bình đúng cách a. Bắt đầu lại chương trình/tốc độ đã chọn bằng cách nhấn nút tương ứng.	a. Tắt cả các đèn LED (trừ Wi-Fi) bắt đầu phát xung trong 3 giây và sau đó chuyển sang ON_IDLE (CHỜ)
		b. Bình được lắp không chính xác hoặc không được cố định sau khi tạm dừng chương trình.	b. Nhấn nút nhấp nháy để tiếp tục với chương trình tạm dừng	b. Tắt cả các đèn LED (trừ Wi-Fi) bắt đầu phát xung trong 3 giây và sau đó trở lại trạng thái PAUSED (TẠM DỪNG).
		a. Nắp không được đặt hoặc định vị đúng vị trí trên Bình trước khi bắt đầu chương trình, xung hoặc lựa chọn tốc độ	Đặt hoặc Di Chuyển nắp đến đúng vị trí a. Bắt đầu lại chương trình/tốc độ đã chọn bằng cách nhấn nút tương ứng.	
		b. Nắp không được đặt hoặc định vị đúng vị trí trên Bình sau khi tạm dừng chương trình.	b. Nhấn nút nhấp nháy để tiếp tục với chương trình tạm dừng	
		Động cơ quá nóng	Tắt Máy Xay, rút phích cắm, đợi trong 10 phút để động cơ nguội đi trước khi bật lại máy xay	Thiết bị tắt và không có chỉ báo đèn LED nào sáng
		Phích cắm không được kết nối đúng với ổ cắm điện hoặc không có điện từ ổ cắm	Kiểm tra kết nối của phích cắm với ổ cắm điện hoặc thử ổ cắm khác	Không có chỉ báo đèn LED nào sáng
		Mất điện	Chờ đến khi có điện để sử dụng sản phẩm	Không có chỉ báo đèn LED nào sáng
Trong APP_Mode (Chế Độ ỨNG DỤNG), máy xay không thể khởi động	Máy xay bị ngắt kết nối mạng. Đảm bảo mạng không dây đang hoạt động với Máy Xay	APP không thể phát hiện thiết bị		
Lỗi Chức Năng	Vui lòng liên hệ với bộ phận hỗ trợ dịch vụ địa phương để được hỗ trợ thêm	Thiết bị không thể hoạt động sau khi thực hiện các biện pháp xử lý sự cố.		

MỤC	DẤU HIỆU	NGUYÊN NHÂN	GIẢI PHÁP	CHỈ BÁO
2	Động cơ chết máy trong khi hoạt động	Bình hoặc Nắp bị tháo ra trong khi Hoạt Động.	Bình và Nắp luôn phải được lắp trong khi hoạt động Lắp và Đặt Bình và Nắp đúng vị trí trên Thiết Bị để tiếp tục sử dụng	Động cơ ngừng chạy a. Tất cả các đèn LED bắt đầu dao động trong 3 giây và sau đó chuyển sang ON_IDLE (CHỜ). B. Giao Diện Người Dùng (UI) tiếp tục trong trạng thái PAUSED (TẠM DỪNG)
		Bảo Vệ Chống Quá Nóng	Nếu động cơ chết máy, hãy tắt máy xay ngay lập tức, rút phích cắm của thiết bị và để nguội ít nhất 10 phút trước khi cắm lại và bật lên.	Thiết bị tắt và không có chỉ báo đèn LED nào sáng
		Các nguyên liệu quá lớn.	Cắt tất cả các nguyên liệu thành những miếng nhỏ hơn Rút phích cắm trong 10 giây và cắm lại máy để tiếp tục sử dụng máy	Thiết bị tắt và không có chỉ báo đèn LED nào sáng
		Sử dụng không đúng cách Bình/Phụ Kiện hoặc Nguyên Liệu	Việc sử dụng Bình và Các Phụ Kiện phải phù hợp với đúng loại nguyên liệu. (Bình được sử dụng để xay Trái Cây và Rau Quả)	Thiết bị tắt và không có chỉ báo đèn LED nào sáng
		Thiết Bị Hẹn Giờ Dừng được Kích Hoạt để ngăn quá nhiệt	Nhấn các nút mong muốn để tiếp tục sử dụng	Thiết bị chạy trên một tốc độ, xung hoặc chương trình liên tục trong 3 phút và dừng lại Tất cả các đèn LED (trừ Wi-Fi) bắt đầu phát xung trong 3 giây và sau đó chuyển sang ON_IDLE (CHỜ)
3	Rò Rỉ Cối Nghiền	Tháo Máy Nghiền khỏi Thiết Bị bằng cách xoay Cối Thủy Tinh thay vì giá đỡ để lắp lưỡi ngược chiều kim đồng hồ có thể nói lỏng Cối Thủy Tinh và khiến dung tích bị rò rỉ.	Xoay Cối Thủy Tinh theo chiều kim đồng hồ cho đến khi gắn chặt vào giá đỡ để lắp lưỡi trước khi lắp vào thiết bị Chỉ xoay giá đỡ để lắp lưỡi Ngược Chiều Kim Đồng Hồ để tháo ra khỏi Thiết Bị Không xoay Cối Thủy Tinh để tháo ra	Dung dịch rò rỉ ra ngoài Cối Thủy Tinh khi tháo ra từ Thiết Bị

MỤC	DẤU HIỆU	NGUYÊN NHÂN	GIẢI PHÁP	CHỈ BÁO
4	Máy bấm không hoạt động khi lắp	Hộp Số Máy Bấm không được lắp với Máy Bấm	Trước tiên cần lắp Hộp Số Máy Bấm, sau đó là Lưỡi Bấm	Khi bất kỳ biểu tượng nào được ấn, Tất Cả Đèn LED sẽ nhấp nháy 3 giây và Máy Bấm không bắt đầu
5	Đăng Ký và Đăng Nhập Tài Khoản Ứng Dụng	Không thể tạo Tài Khoản	Vui lòng sử dụng một địa chỉ email khác để tạo một tài khoản mới hoặc tiếp tục với email để hỗ trợ đặt lại mật khẩu cho tài khoản hiện tại	Quý vị nhận được tin nhắn sau đây khi đăng ký tài khoản mới "Chúng tôi đã gửi cho quý vị một email để quý vị có thể đặt lại mật khẩu của mình"
		a. Lỗi mật khẩu b. Tài khoản không tồn tại	a. Nhấp vào "forgot password" (quên mật khẩu) để nhận một email để hỗ trợ đặt lại mật khẩu b. Nhấp vào "no account?" (không có tài khoản?) để tạo một tài khoản mới	Quý vị nhận được tin nhắn sau đây khi cố gắng đăng nhập "tên người dùng hoặc mật khẩu không hợp lệ"
6	Thiết Bị Tích Hợp	Thiết bị không thể kết nối với SSID WIFI mong muốn	Nhập lại mật khẩu WIFI Thiết lập bộ định tuyến để cho phép Thiết Bị kết nối qua WIFI (Vui lòng tham khảo nhà sản xuất bộ định tuyến của quý vị để được hỗ trợ thiết lập)	Thiết Lập Thất Bại
		Thiết bị không thể phát hiện SSID	Bộ định tuyến WIFI phải phát SSID mạng 2.4 GHZ Thiết lập SSID trong Bộ Định Tuyến không thể được Ẩn (Vui lòng tham khảo nhà sản xuất bộ định tuyến của quý vị để được hỗ trợ thiết lập)	Bộ định tuyến SSID không hiển thị trong Ứng Dụng khi tích hợp
		Trong suốt quá trình kết nối với Thiết Bị, biểu tượng WIFI trên điện thoại liên tục nhấp nháy và thiết lập bị lỗi sau khi cố gắng kết nối	Vui lòng bật GPS trên điện thoại của quý vị và thử kết nối lại với Thiết Bị trong khi tích hợp	GPS trên điện thoại cần được bật để phát hiện AP Thiết Bị. Điều này chỉ cần thiết đối với việc tích hợp

MỤC	DẤU HIỆU	NGUYÊN NHÂN	GIẢI PHÁP	CHỈ BÁO
7	Lỗi trên Ứng Dụng Điện Thoại Di Động	Thiết bị không được kết nối với WIFI	<p>Tham khảo Hướng Dẫn Sử Dụng Bộ Định Tuyến của quý vị để biết khoảng cách hiệu suất tối ưu và khả năng gây trở ngại.</p> <p>Đặt máy xay gần bộ định tuyến nhất có thể để ngăn việc Tín Hiệu WIFI bị mất</p>	<p>Biểu Tượng WIFI tắt và không được kết nối với Mạng WIFI</p> <p>Lỗi trên Ứng Dụng Điện Thoại Di Động khi gửi thiết lập đến Thiết Bị</p>
		Thiết Bị không được bật	<p>Nhấn nút ON (BẬT) ở góc của Thiết Bị</p> <p>Đợi Biểu Tượng WIFI sáng lên trước khi gửi thiết lập từ Ứng Dụng Di Động</p>	

中国

伊莱克斯 (中国) 电器有限公司上海小家电分公司
中国, 上海, 静安区共和新路1968号大宁国际广场
8号楼606室
办公电话: +86 21 3178 1000
传真: +86 21 3387 0368
售后服务: +86 9510 5801
网站: www.electrolux.com.cn

台灣

新加坡商伊莱克斯股份有限公司 台灣分公司
22065新北市板橋區縣民大道2段68號9F
免付費客服專線: 0800-888-259
傳真: 886-2-8964-5269
電郵: service.tw@electrolux.com
網站: www.electrolux.com.tw

KOREA

Electrolux Korea limited
9F, Pine Avenue B,
100 Euljiro, Jung-gu, Seoul, Korea 04551
Korea
Tel : +82 2 6020-2200
Fax: +82 2 6020-2271-3
Customer Care Services : +82 1566-1238
Email : homecare.kr@electrolux.com
Website: www.electrolux.co.kr

INDONESIA

PT. Electrolux Indonesia
Electrolux Building
Jl.Abdul Muis No. 34,
Petojo Selatan, Gambir
Jakarta Pusat 10160
Indonesia
Tel: 021 - 50817300
Fax: 021 - 50817399
Customer Care Services: 0804 111 999
SMS: 0812 8088 8863
Email: customercare@electrolux.co.id
Website: www.electrolux.co.id

PHILIPPINES

Electrolux Philippines, Inc.
10th Floor. W5th Avenue Building
5th Avenue Corner 32nd Street
Bonifacio Global City,
Taguig Philippines 1634
Trunkline: +63 2 737 4756
Domestic Toll Free: 1 800 10 845 care 2273
Customer Care Services: +63 2 845 care 2273
Email: wecare@electrolux.com
Website: www.electrolux.com.ph

THAILAND

Electrolux Thailand Co Ltd
Electrolux Building
14th Floor 1910 New Petchburi Road
Bangkapi, Huay Kwang
Bangkok 10310
Thailand
Tel: +66 2 725 9100
Fax: +66 2 725 9299
Customer Care Services: +66 2 725 9000
Email: customercarethai@electrolux.com
Website: www.electrolux.co.th

VIETNAM

Electrolux Vietnam Ltd
Floor 9th, A&B Tower
76 Le Lai Street
Ben Thanh Ward - District 1
Ho Chi Minh City
Vietnam
Tel: +84 8 3910 5465
Fax: +84 8 3910 5470
Customer Care Services: 1800-58-8899
Email: vncare@electrolux.com
Website: www.electrolux.vn

MALAYSIA

Electrolux Home Appliances Sdn Bhd
Lot C6, No. 28, Jalan 15/22,
Taman Perindustrian Tiong Nam,
40200 Shah Alam, Selangor
Malaysia
Customer Care Services Tel: +60 3 5525 0800
Customer Care Services Fax: +60 3 5524 2521
Email: malaysia.customercare@electrolux.com
Website: www.electrolux.com.my

SINGAPORE

Electrolux SEA Pte Ltd
1 Fusionopolis Place, Galaxis
#07-10 (West Lobby)
Singapore 138522
Customer Care Services: +65 6727 3699
Fax: +65 6727 3611
Email: customer-care.sin@electrolux.com
Website: www.electrolux.com.sg

AUSTRALIA

Electrolux Home Products Pty Ltd
ABN 51 004 762 341
163 O'Riordan Street, Mascot, NSW 2020, Australia
Customer Service Phone: 1300 365 305
Website: www.electrolux.com

NEW ZEALAND

Electrolux Small Appliances
A division of Electrolux (NZ) Limited
3-5 Niall Burgess Road, Mt. Wellington, Auckland,
New Zealand
Phone: (09) 9573 2220
Customer Service Phone: 0508 730 730
Website: www.electrolux.com

HONG KONG

大昌貿易行有限公司
電器維修中心
香港九龍灣啟祥道20號
大昌行集團大廈5樓
服務熱線: +(852) 3193 9888
電子郵件: dthead@ead.dch.com.hk
網頁: www.electrolux.com.hk



Share more of our thinking at www.electrolux.com