

Dimension Guide

Inverter Air Conditioner

Model:
ESV15CRR-B4

Dimensions			
	width	height	depth
Product (mm)	837	296	205

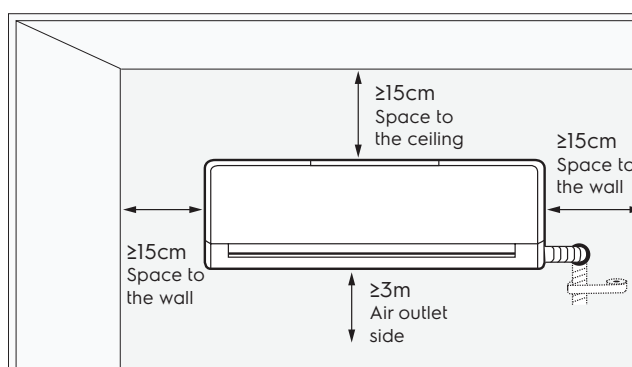
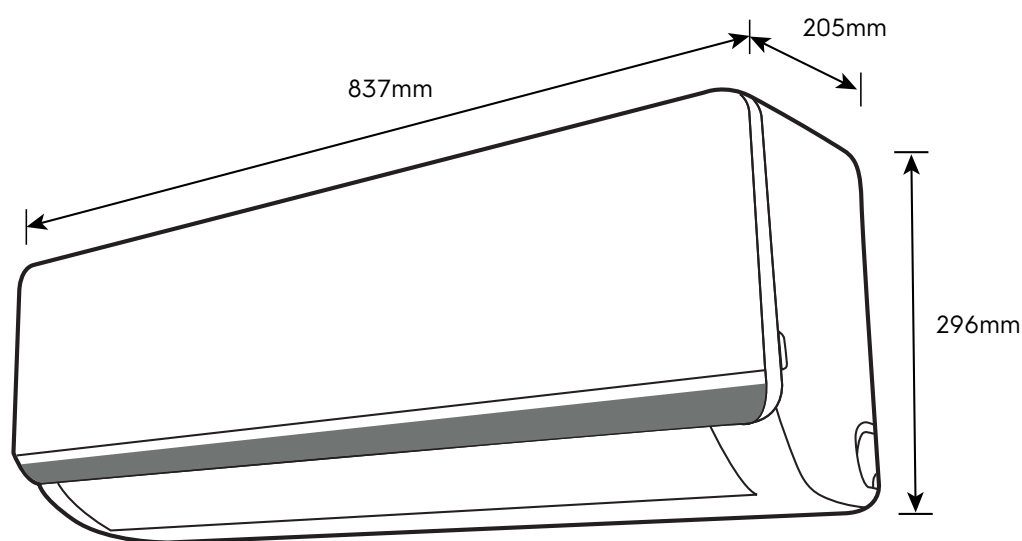

Please note! Dimensions to be used as a guide only. All customers MUST refer to the user manual supplied with the product for detailed installation instructions.
© 2022 Electrolux S.E.A PTE. LTD. E_DIM_ESV15CRR-B4_Feb22