

# Dimension Guide

## Inverter Air Conditioner

**Model:**  
ESV12CRR-B4

Dimensions			
	width	height	depth
Product (mm)	837	296	205

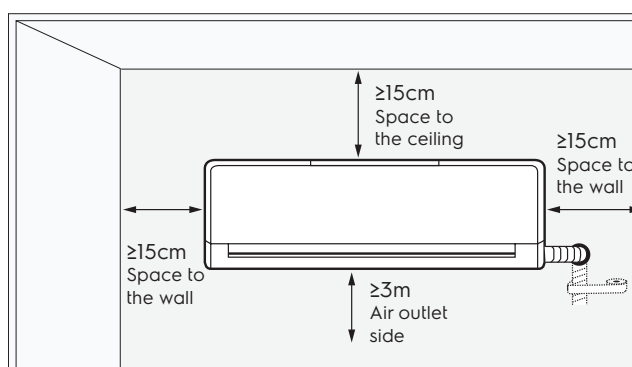
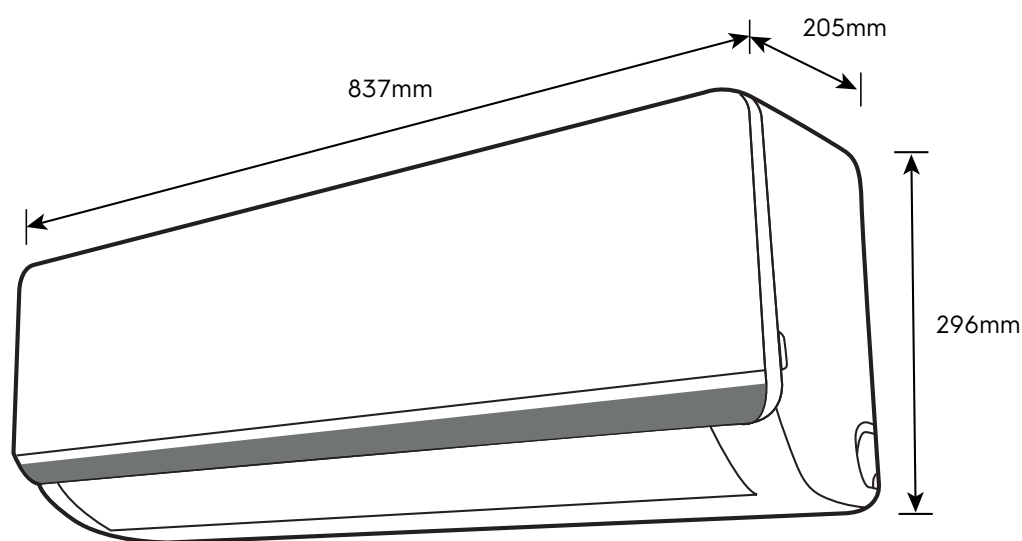

**Please note!** Dimensions to be used as a guide only. All customers MUST refer to the user manual supplied with the product for detailed installation instructions.  
© 2022 Electrolux S.E.A PTE. LTD. E\_DIM\_ESV12CRR-B4\_Feb22