

# Dimension Guide

## Inverter Air Conditioner

**Model:**  
ESV09CRR-B4

Dimensions			
	width	height	depth
Product (mm)	700	285	200

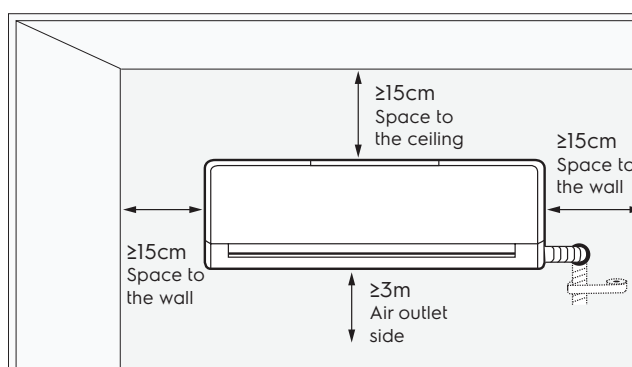
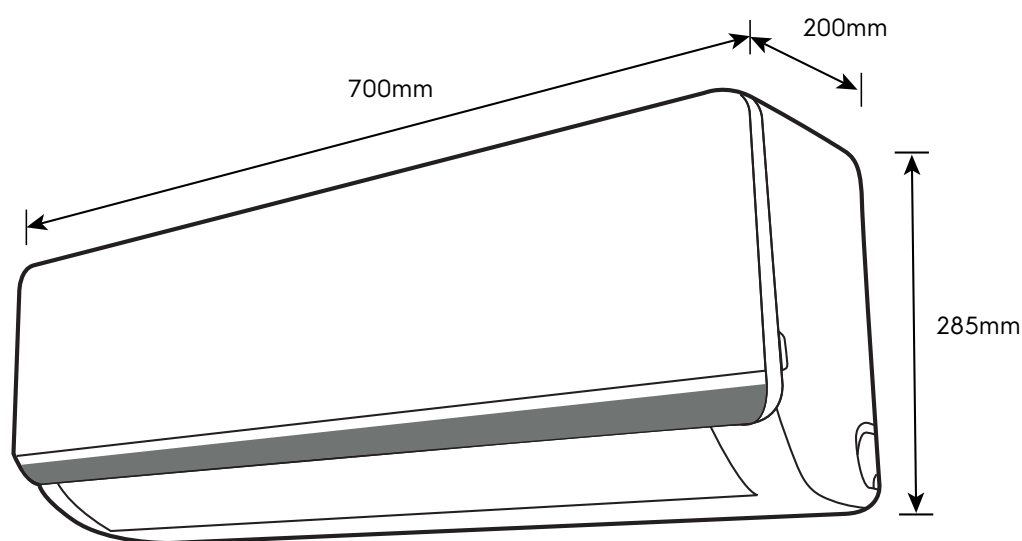

**Please note!** Dimensions to be used as a guide only. All customers MUST refer to the user manual supplied with the product for detailed installation instructions.  
© 2022 Electrolux S.E.A PTE. LTD. E\_DIM\_ESV09CRR-B4\_Feb22