



Electrolux



[electrolux.com/register](https://electrolux.com/register)



KOAAS3SH

KOAAS3ST

EN User Manual | **Steam oven**





# Welcome to Electrolux! Thank you for choosing our appliance.



Get usage advice, brochures, troubleshooting, service and repair information:  
[www.electrolux.com/support](http://www.electrolux.com/support)

Subject to change without notice.

## CONTENTS

1. SAFETY INFORMATION.....	3
2. SAFETY INSTRUCTIONS.....	5
3. PRODUCT DESCRIPTION.....	7
4. CONTROL PANEL.....	8
5. BEFORE FIRST USE.....	8
6. DAILY USE.....	10
7. ADDITIONAL FUNCTIONS.....	14
8. CLOCK FUNCTIONS.....	14
9. USING THE ACCESSORIES.....	15
10. HINTS AND TIPS.....	16
11. CARE AND CLEANING.....	19
12. TROUBLESHOOTING.....	22
13. ENERGY EFFICIENCY.....	24
14. ENVIRONMENTAL CONCERNS.....	25

## 1. ⚠ SAFETY INFORMATION

Before the installation and use of the appliance, carefully read the supplied instructions. The manufacturer is not responsible for any injuries or damage that are the result of incorrect installation or usage. Always keep the instructions in a safe and accessible location for future reference.

### 1.1 Children and vulnerable people safety

- This appliance can be used by children aged from 8 years and above and persons with reduced physical, sensory or mental capabilities or lack of experience and knowledge if they have been given supervision or instruction concerning the use of the appliance in a safe way and understand the hazards involved. Children of less than 8 years of age and persons with very extensive and complex disabilities shall be kept away from the appliance unless continuously supervised.

- Children should be supervised to ensure that they do not play with the appliance and mobile devices with the app.
- Keep all packaging away from children and dispose of it appropriately.
- **WARNING:** The appliance and its accessible parts become hot during use. Keep children and pets away from the appliance when in use and when cooling down.
- If the appliance has a child safety device, it should be activated.
- Children shall not carry out cleaning and user maintenance of the appliance without supervision.

## **1.2 General Safety**

- This appliance is for cooking purposes only.
- This appliance is designed for single household domestic use in an indoor environment.
- This appliance may be used in offices, hotel guest rooms, bed & breakfast guest rooms, farm guest houses and other similar accommodation where such use does not exceed (average) domestic usage levels.
- Only a qualified person must install this appliance and replace the cable.
- Do not use the appliance before installing it in the built-in structure.
- Disconnect the appliance from the power supply before carrying out any maintenance.
- If the supply cord is damaged, it must be replaced by the manufacturer, its Authorised Service Centre or similarly qualified persons to avoid an electrical hazard.
- **WARNING:** Ensure that the appliance is switched off before replacing the lamp to avoid the possibility of electric shock.
- **WARNING:** The appliance and its accessible parts become hot during use. Care should be taken to avoid touching heating elements or the surface of the appliance cavity.
- Always use oven gloves to remove or insert accessories or ovenware.

- Use only the food sensor (core temperature sensor) recommended for this appliance.
- To remove the shelf supports first pull the front of the shelf support and then the rear end away from the side walls. Install the shelf supports in the opposite sequence.
- Do not use a steam cleaner to clean the appliance.
- Do not use harsh abrasive cleaners or sharp metal scrapers to clean the glass door since they can scratch the surface, which may result in shattering of the glass.

## 2. SAFETY INSTRUCTIONS

### 2.1 Installation

#### **WARNING!**

Only a qualified person must install this appliance.

- Remove all the packaging.
- Do not install or use a damaged appliance.
- Follow the installation instructions available on our website.
- Always take care when moving the appliance as it is heavy. Always use safety gloves and enclosed footwear.
- Do not pull the appliance by the handle.
- Install the appliance in a safe and suitable place that meets installation requirements.
- Keep the minimum distance from other appliances and units.
- Before mounting the appliance, check if the appliance door opens without restraint.
- The appliance is equipped with an electric cooling system. It must be operated with the electric power supply.

### 2.2 Electrical connection

#### **WARNING!**

Risk of fire and electric shock.

- All electrical connections should be made by a qualified electrician.
- For Singapore only fixed wiring is used.
- The appliance must be earthed.
- Make sure that the parameters on the rating plate are compatible with the

electrical ratings of the mains power supply.

- Always use a correctly installed shockproof socket.
- Do not use multi-plug adapters and extension cables.
- Make sure not to cause damage to the mains plug and to the mains cable. Should the mains cable need to be replaced, this must be carried out by our Authorised Service Centre.
- Do not let mains cables touch or come near the appliance door or the niche below the appliance, especially when it operates or the door is hot.
- The shock protection of live and insulated parts must be fastened in such a way that it cannot be removed without tools.
- Connect the mains plug to the mains socket only at the end of the installation. Make sure that there is access to the mains plug after the installation.
- If the mains socket is loose, do not connect the mains plug.
- Do not pull the mains cable to disconnect the appliance. Always pull the mains plug.
- Use only correct isolation devices: line protecting cut-outs, fuses (screw type fuses removed from the holder), earth leakage trips and contactors.
- The electrical installation must have an isolation device which lets you disconnect the appliance from the mains at all poles. The isolation device must have a contact opening width of minimum 3 mm.

- This appliance is supplied only with a main cable.

## 2.3 Use

### **WARNING!**

Risk of injury, burns and electric shock or explosion.

- Do not change the specification of this appliance.
- Make sure that the ventilation openings are not blocked.
- Do not let the appliance stay unattended during operation.
- Deactivate the appliance after each use.
- Be careful when you open the appliance door while the appliance is in operation. Hot air can be released.
- Do not operate the appliance with wet hands or when it comes in contact with water.
- Do not apply pressure on the open door.
- Do not use the appliance as a work surface or as a storage surface.
- Open the appliance door carefully. The use of ingredients with alcohol can cause a mixture of alcohol and air.
- Do not let sparks or open flames to come in contact with the appliance when you open the door.
- Always use glass and jars approved for preserving purposes.
- Do not put flammable products or items moistened with flammable products in, near or on the appliance.
- Do not share your Wi-Fi password.

### **WARNING!**

Risk of damage to the appliance.

- To prevent damage or discolouration to the enamel:
  - do not put ovenware or other objects directly on the bottom of the appliance's cavity.
  - do not put aluminium foil directly on the bottom of cavity of the appliance.
  - do not put water directly into the hot appliance.
  - do not keep moist dishes and food in the appliance after you finish the cooking.

- be careful when you remove or install the accessories.
- Discolouration of the enamel or stainless steel has no effect on the performance of the appliance.
- Use a deep pan for moist cakes. Fruit juices cause stains that can be permanent.
- Use only accessories supplied with this appliance or recommended by the manufacturer.
- Always cook with the appliance door closed.
- If the appliance is installed behind a furniture panel (e.g. a door) make sure the door is never closed when the appliance operates. Heat and moisture can build up behind a closed furniture panel and cause subsequent damage to the appliance, the housing unit or the floor. Do not close the furniture panel until the appliance has cooled down completely after use.

## 2.4 Care and cleaning

### **WARNING!**

Risk of injury, fire, or damage to the appliance.

- Before maintenance, deactivate the appliance and disconnect the mains plug from the mains socket.
- Make sure the appliance is cold. There is the risk that the glass panels can break.
- Replace immediately the door glass panels when they are damaged. Contact the Authorised Service Centre.
- Be careful when you remove the door from the appliance, the door is heavy.
- Clean regularly the appliance to prevent the deterioration of the surface material.
- Clean the appliance with a moist soft cloth. Use only neutral detergents. Do not use abrasive products, abrasive cleaning pads, solvents or metal objects.
- If you use an oven spray, follow the safety instructions on its packaging.

## 2.5 Steam Cooking

### **⚠ WARNING!**

Risk of burns and damage to the appliance.

- Released Steam can cause burns:
  - Be careful when you open the appliance door when the function is activated. Steam can be released.
  - Open the appliance door with care after the steam cooking operation.

## 2.6 Internal lighting

### **⚠ WARNING!**

Risk of electric shock.

- Concerning the lamp(s) inside this product and spare part lamps sold separately: These lamps are intended to withstand extreme physical conditions in household appliances, such as temperature, vibration, humidity, or are intended to signal information about the operational status of the appliance. They are not

intended to be used in other applications and are not suitable for household room illumination.

- This product contains a light source of energy efficiency class G.
- Use only lamps with the same specifications.

## 2.7 Service

- To repair the appliance contact the Authorised Service Centre.
- Use original spare parts only.

## 2.8 Disposal

### **⚠ WARNING!**

Risk of injury or suffocation.

- Contact your municipal authority for information on how to dispose of the appliance.
- Disconnect the appliance from the mains supply.
- Cut off the mains electrical cable close to the appliance and dispose of it.

## 3. PRODUCT DESCRIPTION

### 3.1 General overview

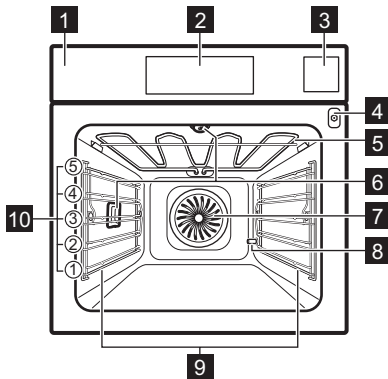

- 1 Control panel
- 2 Display
- 3 Water tank
- 4 Socket for the food sensor
- 5 Heating element
- 6 Lamp
- 7 Fan
- 8 Descaling pipe outlet
- 9 Shelf support, removable
- 10 Shelf positions

## 4. CONTROL PANEL

### 4.1 Control panel overview

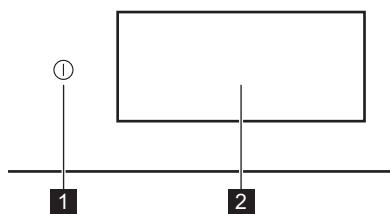

**1** ON / OFF Press and hold to turn the appliance on and off.

**2** Display Shows the current settings of the appliance.

The control panel provides access to various cooking functions and dishes. It also displays the information about its current operating status.

### 4.2 Display

The display is fully interactive, scrollable and divided into defined sections. You can swipe across the screen to navigate left or right.

OK To confirm the selection / setting.

> < To navigate to the next or previous level in the menu.

^ v To access and adjust additional settings.

♥ To save current settings in: Favourites.

♡ To delete current settings in: Favourites.

⚙ To go to menu: Settings.

☹ To turn the lamp on and off.

☑ To turn the options on and off.

🔒 The appliance is locked.

🔔 Sound Alarm function is activated.

🔔🛑 Sound Alarm and stop cooking function is activated.

🗨 Pop up message only is activated.

🕒 Delayed start function is activated.

✕ To close the pop-up message or cancel the setting.

📶 Wi-Fi connection is turned on.

📶🚫 Wi-Fi connection is turned off.

📶🏠 Remote Operation is turned on.

🕒🌙 Function with energy saving mode.

## 5. BEFORE FIRST USE

### ⚠ WARNING!

Refer to Safety chapters.

### 5.1 First connection

The display shows welcome message after the first connection. You can choose between starting or skipping the onboarding process. The settings can be revisited and modified whenever it is necessary.

Adjust the settings: Language, Time of Day, Water Hardness, Wireless connection.

### 5.2 Wireless connection

The appliance enables Wi-Fi network connection and mobile device linking. You can receive notifications, control and monitor your appliance from your mobile device.

To connect the appliance you need:

- Wireless network with the Internet connection.
- Mobile device connected to the same wireless network.

1. To download the app scan the QR code located on the back cover of user manual.

You can also download the app directly from the app store.

2. Follow the app onboarding instructions.
3. Turn on the appliance.
4. Press the display to enter menu and press  Settings / Connections.
5. Press to turn on or off: Wi-Fi.

The appliance wireless module starts within 90 sec.

Frequency	2.4 GHz WLAN : 2400 - 2483.5 MHz
	Bluetooth : 2400 - 2483.5 MHz
Max Power	2.4 GHz WLAN : EIRP < 20 dBm (100 mW)
	Bluetooth : EIRP < 20 dBm (100 mW)
Protocol	2.4 GHz WLAN : IEEE 802.11bgn



### 5.3 Software licences

The software in this product contains components that are based on free and open source software. Electrolux acknowledges the contributions of the open software and robotics communities to the development project.

To access the source code of these free and open source software components whose license conditions require publishing, and to see their full copyright information and applicable license terms, visit: [http://electrolux.opensourcerepository.com \(folder NIU6\)](http://electrolux.opensourcerepository.com (folder NIU6)).

### 5.4 Initial preheating and cleaning

Preheat the empty appliance before the first use and contact with food. The appliance can emit unpleasant smell and smoke. Ventilate the room during preheating.

1. Remove all accessories and removable shelf supports from the appliance.
2. Enter menu and select: Functions.
3. Set the function . Set the maximum temperature. Let the appliance operate for 1 h.
4. Set the function . Set the maximum temperature. Let the appliance operate for 15 min.

5. Set the function . Set the maximum temperature. Let the appliance operate for 15 min.
6. Turn off the appliance and wait until it is cold.
7. Clean the appliance and the accessories only with a microfibre cloth, warm water and a mild detergent.
8. Put the accessories and removable shelf supports back to their initial position.

### 5.5 Setting: Water Hardness





When you connect the appliance to the mains you have to set the water hardness level.

Use the test paper or contact your water supplier to check the water hardness level.

1. Put the test paper into the tap water for about 1 sec. Do not put the test paper under running water.
2. Shake the test paper to remove any remaining water.
3. After 1 min, check water hardness with the table below.
4. Set the water hardness level  Settings / Setup / Water Hardness.

The colours of the test paper continue to change. Check the water hardness within 1 min after testing.

The table shows water hardness range with the corresponding level of water classification. Adjust the water hardness level according to the table.

Water hardness level	Test paper
1 - soft	
2 - moderately hard	
3 - hard	
4 - very hard	

## 6. DAILY USE

### **WARNING!**

Refer to Safety chapters.

### 6.1 Menu

Press the display or the ON / OFF button to enter menu.

- Home
- Functions
- Dishes
- Settings

### 6.2 Home

Submenu includes programmes, functions, dishes and settings.

### 6.3 Functions

Submenu includes a list of cooking functions.

The list of functions may vary depending on the software version.

1. Enter menu and select: Functions.
2. Select the heating function.
3. Adjust the settings.
4. Press **START** . You can plug the Food Sensor at any time before or during cooking. Refer to "Using the accessories, Food sensor" chapter.
5. **^** - press to adjust the settings during cooking.
6. **STOP** - press to turn off the heating function.



Fast Preheat is available only for some heating functions. For more information on preheat options refer to "Daily use" chapter, Settings, Submenu: Preferences.



#### **Top**

Intense heat for rapid browning on top.



#### **Bottom**

Evenly brown bottom of food. Good for pizza or pie, and finishing cakes or quiches. Pre-heat the oven and use lowest shelf level.



#### **Hot Air**

For everyday cooking on multiple levels. Get evenly cooked dishes without mixing flavours. Set a lower temperature than for Top & Bottom.



#### **Top & Bottom**

For everyday cooking on a single level. Good for all foods, like casseroles and baked goods.



#### **Hot air & Top**

Roast larger meat joints and poultry with bones for tender results and crispy surface.



#### **Hot air & Bottom**

Evenly bake dough with a crispy crust. Good for pizza, quiche, tart, or pie.



#### **Hot air, Top & Bottom**

This function is ideal for ready meals.



#### **Steamify**

Matching the right Steam amount with selected temperature.



#### **ProSteam**

Get tender results and crispy surface with combination of steam and heat. Good for vegetables, casseroles, and meat.



#### **Heat Save Fan**

Save energy by using residual heat to cook. Best for pastries.



#### **Steam**

Continuous steam for healthy and flavourful food.



#### **Reheat**

This function gently reheats leftovers with steam.



#### **Grill**

Evenly grill or brown vegetables or meat. Also good for toasting bread.



#### **SousVide**

Cook vacuum-sealed food at precise temperature for best taste and texture.



#### **Dough Prove**

Optimized temperature for fast rising.

**Refresh**

Bring back a fresh smell and soft inside to day-old bread or baked goods.

**Defrost**

Gentle defrosting for further preparation.

**Stew**

Get tender, juicy stews by simmering the ingredients all together.

**Roast**

Get a crispy outside and tender inside for meat, poultry, or vegetables.

**Bread Baking**

Use this function to prepare bread and bread rolls with professional-like result in terms of crispiness, colour and crust gloss.

**Slow cook**

Slow cooking increases the cooking time, but you will get a better cooking result. Before you put the meat in the oven, sear it.

**Preserve**

Get juicy fruits and vegetables canned at a low temperature. Put the heat resistant canning jars on a baking tray filled with water.

**Plate warming**

To preheat plates before serving.

**Keep Warm**

Keep dishes warm to be served. Please note that some dishes may continue to cook and dry out while being kept warm. Cover the dishes if necessary.

**Dehydrate**

Evenly dry out fruits, herbs, and vegetables at a low temperature. Open the door occasionally during drying to improve the drying result.



The lamp may turn off automatically at a temperature below 80 °C during some heating functions.

## 6.4 Dishes

Dishes submenu consists of a set of programmes that are designed for dedicated dishes. Each dish in this submenu is provided with a suitable setting. The time and temperature can be adjusted during cooking.

For some of the dishes you can also cook with Food Sensor.

1. Enter menu and select: Dishes.

2. Choose a dish or a food type.
  3. Adjust settings according to cooking preferences. Adjust the weight. Option is available for selected dishes. Press **OK**.
  4. Place the food inside the appliance according to the instructions available on the screen.
  5. Press **START**.
- When the function ends, check if the food is ready. Extend the cooking time, if needed.

## 6.5 Favourites



This functionality is available for selected models only.

You can save up to 20 of your favourite settings, such as heating function, dish or cleaning function.

To save the setting select the preferred setting and press .

### Select: Favourites

1. Enter menu and press: Home section and move the scroll bar to the right.
2. Press: View favourites to check the saved settings.
3. Select one of the saved settings.
4. Press **START** to start cooking.

### Delete: Favourites

1. Enter menu and select: Home section and move the scroll bar to the right.
2. Press: View favourites to check the saved settings.
3. Press: to delete the saved settings.

## 6.6 Settings

This submenu includes a list of settings.

Press the display or the ON / OFF button to enter menu and press Settings.

## Submenu: Maintenance programmes

Steam Cleaning	Light cleaning.
Steam Cleaning Plus	Normal cleaning.
Descaling	Cleaning of the steam generation circuit from residual limestone.
Drying	Process for drying the cavity from the condensation remaining after the use of steam functions.
Rinsing	Process for rinsing and cleaning the steam generation circuit after frequent use of the steam functions.

## Submenu: Setup

Language	To set the appliance language.
Time of Day	To set the current time.
Display Brightness	To set the display brightness.
Key Tones	To turn the tone of the touch fields on and off. It is not possible to mute the tones for  .
Buzzer Volume	To set the volume of key tones and signals.
Temperature unit	To show the current temperature unit.
Water Hardness	To set the water hardness.

## Submenu: Service

Demo Mode	Activation / deactivation code: 2468
Software Version	Information about software version.
Reset All Settings	Restores factory settings.

## Submenu: Preferences

Light	Turns the lamp on and off.
Child Lock	Prevents accidental activation of the appliance.

Preheat/HeatUp	None - conventional way of preheating the appliance. It is set as default and available for all cooking functions. The preference can be changed to another preheat type.
	Eco - preheating the appliance with less energy consumption. It is available for all cooking functions.
	Fast - shortens the heat up time. It is available for some of the functions only.
Cleaning Reminder	Reminds you when to clean the appliance.
Personalisation	To customize the screen features and shortcuts.



## Submenu: Connections

Connect To Wi-Fi	To connect the appliance with the wireless network.
Wi-Fi	To enable and disable: Wi-Fi.
Network	To check network status and the signal power of: Wi-Fi.
Forget Network	To disable current network from auto connection with the appliance.
Remote Operation	To start remote operation automatically after pressing START. Option visible only after you turn on: Wi-Fi.

## 6.7 Steam heating functions

These functions allow you to use heat and steam to keep meals crispy and juicy. Use them for steaming, stewing, gentle crisping, baking and roasting.

There are two ways to prepare food using the steam functions: by setting the temperature, or by setting the steam level.

 **Steamify** /  **Steam** - set the temperature. The steam level will be adjusted automatically.

 **ProSteam** - set the steam level. The suitable temperature will be shown.

1. Enter the menu and select: Functions.
2. Set the steam heating function. The display shows available settings.

3. Set the temperature and the steam level, if available.
4. Press **START** and follow the instruction on the display.
5. Press the cover of the water tank to open and remove it.
6. Fill the water tank with cold water to the maximum level (around 950 ml). Use the scale on the water tank.

**⚠ WARNING!**  
Use only cold tap water. Do not use demineralised or distilled water. Do not pour flammable or alcoholic liquids into the water tank.

7. Wipe the outside of the water tank with a soft cloth, if needed. Push the water tank to its initial position.

Steam appears after approximately 2 min. When the appliance reaches the set temperature, the signal sounds.

8. When the water tank runs out of water, the signal sounds. Refill the water tank.
9. Turn off the appliance.
10. Empty the water tank.
11. After cooking, carefully open the oven door. Residual water can condensate in the oven interior.
12. When the appliance is cold, dry the oven interior with a soft cloth.

**⚠ WARNING!**  
The appliance is hot. There is a risk of burns. Be careful while emptying the water tank.

### 6.8 SousVide

This programme is a cooking technique where food in a vacuum-sealed container is placed in a saturated steam atmosphere, held at a constant temperature. For a more sustainable way of cooking liquid types of food, e.g. desserts and sauces can be cooked in sealed canning jars as well.

1. Prepare ingredients in a vacuum-sealed container and place it on the wire shelf.
2. Enter menu and select: Functions.
3. Press **[SousVide]**.
4. Set the temperature and cooking time.
5. Press **START** and follow the instruction on the display.

6. After cooking, carefully open the oven door. Residual water can condensate in the oven interior and vacuum-sealed containers.
7. When the appliance is cold, remove the water from the bottom of the oven interior with a sponge. Dry the oven interior with a soft cloth.

**⚠ WARNING!**  
There is a risk of burns. Be careful when you take out the food from the appliance.

### 6.9 Water tank

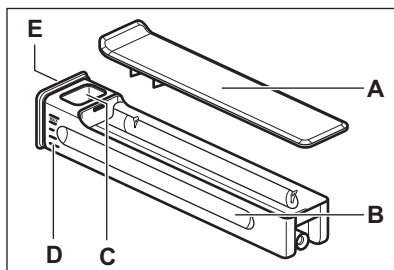

- A. Lid
- B. Tank
- C. Water inlet opening
- D. Scale
- E. Front cover

### 6.10 Notes on: Heat Save Fan

This function was used to comply with the energy efficiency class and ecodesign requirements (according to EU 65/2014 and EU 66/2014). Tests according to: IEC/EN 60350-1.

The oven door should be closed during cooking so that the function is not interrupted and the oven operates with the highest energy efficiency possible.

When you use this function the lamp automatically turns off after 30 sec.

For the cooking instructions refer to Hints and tips, Heat Save Fan. For general energy saving recommendations refer to Energy efficiency, Energy saving tips.

## 7. ADDITIONAL FUNCTIONS

### 7.1 Child Lock



This function prevents accidental operation of the appliance. It can be activated at any time.

1. Enter menu.
2. Select  / Preferences / Child Lock. Child Lock is activated. To enable the use of the appliance, press the code letters in an alphabetical order.

### 7.2 Automatic switch-off

For safety reasons, if the heating function is active and no settings are changed, the appliance will turn off automatically after a certain period of time.

 (°C)	 (h)
30 - 115	12.5

 (°C)	 (h)
120 - 195	8.5
200 - 230	5.5



If you intend to run a heating function for a duration exceeding the automatic switch-off time, set the cooking time. Refer to Clock functions.

### 7.3 Cooling fan

When the appliance operates, the cooling fan turns on automatically to keep the surfaces of the appliance cool. If you turn off the appliance, the cooling fan can continue to operate until the appliance cools down.

## 8. CLOCK FUNCTIONS

### 8.1 Clock functions description

Function	Description
Timer	To set the cooking duration. Maximum is 23 h 59 min. To set what happens when the time is up select preferred: End Action. Timer can be used independently, even when the oven is not running.
End Action	 <b>Sound Alarm</b> When the time is up the signal sounds. This function can be set at any time, even when the appliance is turned off.
	 <b>Sound Alarm and stop cooking</b> When the time is up the signal sounds and the heating function turns off.
	 <b>Pop up message only</b> When the time is up the message appears on the display. This function has no effect on the operation of the appliance.
Delayed start	To postpone the start and / or end of cooking.

Function	Description
Time Extension	To extend the cooking time.
Uptimer	To show how long the appliance operates. Maximum is 23 h 59 min. It starts automatically when an oven process is started and stops when the process is finished. It is visible on the main screen in case where no other timer is set. This function has no effect on the operation of the appliance.

### 8.2 Timer

1. Choose the heating function and set the temperature.
2. Press: Timer.
3. Set the duration. You can select the preferred end action by pressing one of the symbols.
4. Press **OK** to confirm and return to the main screen.

### 8.3 Delayed start

1. Choose the heating function and adjust the settings.
2. Press **...**.
3. Press: Delayed start.
4. Scroll to set desired start time and press **OK**.
5. You can now set desired End time or press **OK** to skip this step.
6. Press **OK** to return to the main screen.

### 8.4 Time of Day

1. Turn on the appliance.

2. Press  / Setup / Time of Day.
3. Set the time.
4. Press **OK**.

### 8.5 Changing timer settings

You can change the set time during cooking at any time.

1. Press **^** / Timer.
2. Set new timer value. Press **OK**.

## 9. USING THE ACCESSORIES

### **WARNING!**

Refer to Safety chapters.

### 9.1 Inserting accessories

Accessories available depending on model. Scan the QR code to check how to use accessories supplied with your appliance. You can order optional accessories separately. For more information, please contact your local supplier.



A small indentation at the top increases safety and provides tilt protection. The indentations are also anti-tip devices. The rim around the shelf prevents cookware from slipping off the shelf.

Insert the accessory (wire shelf / tray) between the guide bars of the shelf support. Make sure that the shelf touches the back of the oven interior.

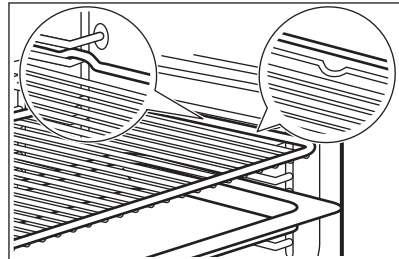

If your tray has a slope, position it towards the back of the oven interior.

If your wire shelf has a step, position it towards the front of the oven interior.

If there is an inscription on the accessory, make sure it is facing you.

If you are using a tray with holes place the tray / pan underneath, to collect dripping liquids.

### 9.2 Food Sensor

It measures the temperature inside the food.

There are two temperatures to be set:

- $^{\circ}\text{C}$  - the temperature inside the appliance. It should be at least  $25^{\circ}\text{C}$  higher than the food core temperature.
-  - the food core temperature.

Recommendations:

- Ingredients should be at room temperature.
- Do not use it for liquid dishes.
- During cooking the needle of the food sensor must be fully inserted in the dish.

## Cooking with: Food Sensor

### **WARNING!**

There is a risk of burns as Food Sensor and shelf supports become hot. Do not touch Food Sensor handle with bare hands. Always use oven gloves.

1. Select a heating function from the menu: Functions or a dish from the menu: Dishes.
2. Set the oven temperature and cooking time, if needed.
3. Press **OK**.
4. Press **START**.
5. Insert Food Sensor inside the dish: **Meat, poultry and fish**  
Insert the entire needle of the Food Sensor into the meat or fish at its thickest part.

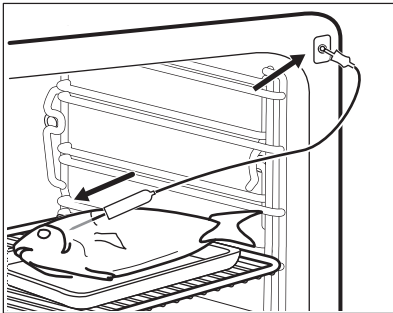

### **Casserole**

Insert the tip of Food Sensor exactly in the centre of the casserole. Food Sensor

should be stabilized in one place during cooking. Use a solid ingredient to achieve that. Use the rim of the baking dish to support the silicone handle of Food Sensor. The tip of Food Sensor should not touch the bottom of a baking dish.

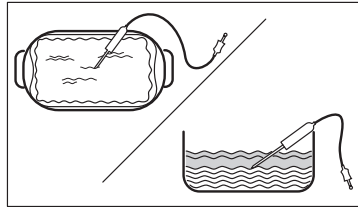

6. Plug Food Sensor into the socket located inside the appliance. Refer to "Product description" chapter.

The display shows the symbol and the current temperature of Food Sensor.

7. **^** - press to adjust the settings.
8. Select Food Sensor card to set the core temperature of the sensor or set up the preferred option:
  - Sound Alarm - when food reaches the core temperature, the signal sounds.
  - Sound Alarm and stop cooking - when food reaches the core temperature, the signal sounds and the cooking stops.
  - Pop up message only - when food reaches the core temperature, the message appears on the display.
9. Press **OK**.
10. When the food reaches the set temperature, the signal sounds. Check if the food is ready. Extend the cooking time, if needed.
11. **STOP** - press to turn off the heating function.
12. Remove Food Sensor plug from the socket and remove the dish from the appliance.

## 10. HINTS AND TIPS

### 10.1 Cooking recommendations

The temperature and cooking times in the tables are for guidance only. They depend on the recipes, quality and quantity of the ingredients used.







Your appliance may bake or roast differently than your previous appliance. The hints below show recommended settings for temperature, cooking time and shelf position for specific types of food.

Count the shelf positions from the bottom of the oven floor.

If you cannot find the settings for a specific recipe, look for a similar one.

For energy saving tips refer to Energy efficiency.

### Symbols used in the tables:

	Food type
	Heating function
	Temperature
	Accessory
	Container (Gastronorm)
	Weight (kg)
	Shelf position

 Cooking time (min)





## 10.2 Heat Save Fan - recommended accessories

Use dark and non-reflective tins and containers. They have better heat absorption than light colour and reflective dishes.

- **Pizza pan** - dark, non-reflective, diameter 28 cm
- **Baking dish** - dark, non-reflective, diameter 26 cm
- **Ramekins** - ceramic, diameter 8 cm, height 5 cm
- **Flan base tin** - dark, non-reflective, diameter 28 cm

## 10.3 Heat Save Fan





For the best results follow suggestions listed in the table below.





		°C		
Sweet rolls, 16 pieces	baking tray or dripping pan	180	2	25 - 35
Swiss Roll	baking tray or dripping pan	180	2	15 - 25
Whole fish, 0.2 kg	baking tray or dripping pan	180	3	15 - 25
Cookies, 16 pieces	baking tray or dripping pan	180	2	20 - 30
Macaroons, 24 pieces	baking tray or dripping pan	160	2	25 - 35
Muffins, 12 pieces	baking tray or dripping pan	180	2	20 - 30
Savory pastry, 20 pieces	baking tray or dripping pan	180	2	20 - 30
Short crust biscuits, 20 pieces	baking tray or dripping pan	140	2	15 - 25
Tartlets, 8 pieces	baking tray or dripping pan	180	2	15 - 25

## 10.4 Information for test institutes

Tests according to: EN 60350-1, IEC 60350-1.

### Baking on one level

			°C		
Fatless sponge cake	Hot Air	Wire shelf	160	45 - 60	2





			°C		
Fatless sponge cake	Top & Bottom	Wire shelf	160	45 - 60	2
Apple pie <sup>1)</sup>	Hot Air	Wire shelf	160	55 - 65	2
Apple pie <sup>1)</sup>	Top & Bottom	Wire shelf	180	55 - 65	1
Short bread	Hot Air	Baking tray	140	25 - 35	2
Short bread	Top & Bottom	Baking tray	140	25 - 35	2
Small cakes, 20 per tray <sup>2)</sup>	Hot Air	Baking tray	150	20 - 30	3
Small cakes, 20 per tray <sup>2)</sup>	Top & Bottom	Baking tray	170	20 - 30	3
Toast <sup>3)</sup>	Top	Wire shelf	max.	1 - 2	5

1) 2 tins placed diagonally (Ø 20 cm). The right one to be positioned more in the front than the left one.

2) Preheat the appliance until set temperature is reached using the setting: Preheat / None. Do not use: Preheat / Fast and Eco. Refer to Daily use, Settings, Submenu: Preferences.

3) Preheat the appliance for 5 min using the setting: Preheat / None. Do not use: Preheat / Fast and Eco. Refer to Daily use, Settings, Submenu: Preferences.

### Multilevel baking

			°C		
Short bread	Hot Air	Baking tray	140	25 - 45	2 and 4
Small cakes, 20 per tray <sup>1)</sup>	Hot Air	Baking tray	150	25 - 35	2 and 4
Fatless sponge cake	Hot Air	Wire shelf	160	45 - 55	2 and 4
Apple pie	Hot Air	Wire shelf	160	55 - 65	2 and 4





1) Preheat the appliance until set temperature is reached using the setting: Preheat / None. Do not use: Preheat / Fast and Eco. Refer to Daily use, Settings, Submenu: Preferences.

## 10.5 Information for test institutes

Use the function: ProSteam, level: Full Steam.

Tests according to EN 60350-1, IEC 60350-1.







Set the temperature to 100°C.

				
Broccoli <sup>1) 2)</sup>	2/3 Steam set perforated	0.3	3	8 - 9
Broccoli <sup>1) 2)</sup>	2/3 Steam set perforated	max.	3	10 - 11
Peas, frozen <sup>2)</sup>	2 x 2/3 Steam set perforated	2 x 1.5	2 and 4	Until the temperature in the coldest spot reaches 85°C.

1) Preheat the appliance until set temperature is reached using the setting: Preheat / None. Do not use: Preheat / Fast and Eco. Refer to Daily use, Settings, Submenu: Preferences.

2) Put the baking tray on the first shelf position, with the slope towards the back of the oven interior.

## Additional steam recipes

					
Steaming combined dish (2 portions) <b>1)</b>	ProSteam, level: Full Steam	Gastronorm 1/2 perforated (potatoes and broccoli) and non-perforated (salmon)	2 (Salmon) 4 (Broccoli and potatoes)	100	40 (Potatoes) 18 - 20 (Salmon) 10 - 12 (Broccoli)
Caramel pudding (6 portions)	ProSteam, level: Humidity High	Round porcelain dishes on wire shelf	2	90	35 - 45
Egg custard	ProSteam, level: Full Steam	Gastronorm 1/2 non perforated	2	85	35 - 45
White Bread	Bread Baking, food type: Bread	Baking tray <sup>2)</sup>	2	180	40 - 50
	ProSteam, level: Humidity Low <sup>3)</sup>				40 - 50
Chicken <sup>4)</sup>	ProSteam, level: Humidity Low	Wire shelf	2	200	60 - 70

**1)** Place the ingredients in the oven one after the other at the appropriate point in time, so that all components are cooked at the same time. You can prepare two portions at the same time.

**2)** Use baking tray with the slope towards the back of the oven interior.

**3)** Use ProSteam only if Bread Baking function is not available.

**4)** Put the baking tray on the first shelf position to collect dripping fat.

## 11. CARE AND CLEANING

### **WARNING!**

Refer to Safety chapters.

### 11.1 Notes on cleaning

#### Cleaning agents

- Clean the front of the appliance only with a microfibre cloth with warm water and a mild detergent.
- Clean the bottom of the cavity with a few drops of vinegar or citric acid to remove limestone residue.
- Use a cleaning solution to clean metal surfaces.
- Clean stains with a mild detergent.

#### Everyday use

- Clean the interior of the appliance after each use. Fat accumulation or other residue may cause fire.
- Do not store food in the appliance for longer than 20 minutes. Dry the interior of the appliance only with a microfibre cloth after each use.

### Accessories

- Clean all accessories after each use and let them dry. Use only a microfibre cloth with warm water and a mild detergent. Do not clean the accessories in a dishwasher.
- Do not clean the non-stick accessories using abrasive cleaner or sharp-edged objects.

### 11.2 Removing the shelf supports

Remove the shelf supports to clean the appliance.

1. Turn off the appliance and wait until it is cold.
2. Carefully pull the shelf supports up and out of the front catch.
3. Pull the front end of the shelf support away from the side wall.
4. Pull the supports out of the rear catch.

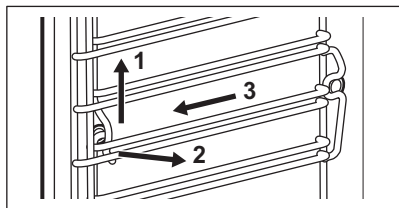

Install the shelf supports in the opposite sequence.

If the telescopic runners are supplied, its retaining pins must point to the front.

### 11.3 Steam Cleaning

This programme cleans the appliance when it is slightly soiled. The steam softens grease or residue, making it easier to clean. This programme uses less energy.

1. Press Settings / Maintenance Programmes / Steam Cleaning or Steam Cleaning Plus.

Mode	Description
Steam Cleaning	Light cleaning <b>Duration:</b> 30 min
Steam Cleaning Plus	Normal cleaning Spray the cavity with a detergent. <b>Duration:</b> 75 min

2. Press **START**. Follow the instruction on the display.  
Before you remove the accessories, make sure the appliance is cold.
3. The signal sounds when the cleaning ends.
4. Remove the remaining water from the water tank.
5. Leave the appliance door open and wait until the interior is dry.



When this function works, the lamp is off.

### 11.4 Cleaning Reminder

When the reminder appears, cleaning is recommended.

Use the function: Steam Cleaning Plus.

### 11.5 Cleaning the water tank

1. Remove the water tank from the appliance.
2. Remove the lid of the water tank. Lift the cover in correspondence with the protrusion in the rear.

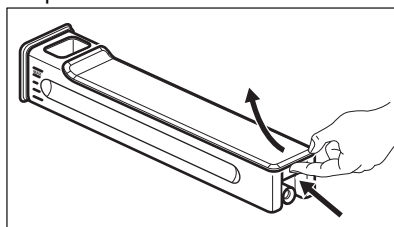

3. Wash the water tank parts with water and soap. Do not use abrasive sponges and do not clean the water tank in a dishwasher.
4. Reassemble the water tank.
5. Assemble the lid. First insert the front snap and then push it against the tank body.

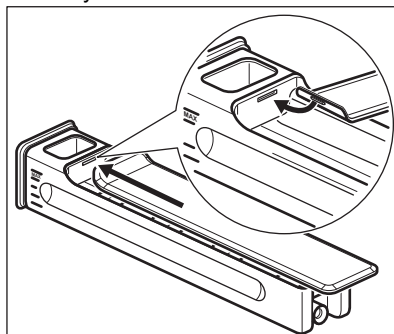

6. Insert the water tank.
7. Push the water tank towards the appliance until it latches.

### 11.6 Descaling

This programme removes and prevents limescale buildup in the steam system. It ensures the proper functioning of the steam functions and enhances the water quality in your appliance.

1. Press Settings / Maintenance Programmes / Descaling.
2. Press **START** and follow the instruction on the display.

- Before you remove the accessories, make sure the appliance is cold.
- When the function ends, turn off the appliance and wait until it is cold.
  - Remove the remaining water from the water tank.
  - Leave the appliance door open and wait until the interior is dry.



When this function works, the lamp is off.

## 11.7 Descaling reminder

The appliance provides two reminders for descaling. The descaling reminder cannot be deactivated.

- Soft reminder - recommends you to descale the appliance.
- Hard reminder - obligates you to descale the appliance. If you do not descale the appliance when the hard reminder is on, the steam functions are disabled.

## 11.8 Rinsing

Use it to clean the steam system after frequent use of the steam functions.

- Press Settings / Maintenance Programmes / Rinsing.
- Press START and follow the instruction on the display.  
Before you remove the accessories, make sure the appliance is cold.
- The signal sounds when the procedure ends.
- Leave the appliance door open and wait until the interior is dry.



When this function works, the lamp is off.

## 11.9 Drying

Use it after cooking with a steam heating function or steam cleaning to dry the cavity.

The excess of water on the cavity bottom needs to be removed before starting the drying process.

- Press Settings / Maintenance Programmes / Drying.

- Press START and follow the instruction on the display.  
Before you remove the accessories, make sure the appliance is cold.
- The signal sounds when the drying ends.



When this function works, the lamp is off.

## 11.10 Drying reminder

After cooking with a steam heating function the display prompts to dry the appliance.

Press YES to dry the appliance.

## 11.11 Removing and installing door

You can remove the door and the internal glass panels to clean it. The number of glass panels is different for different models.

### WARNING!

The door is heavy.

### CAUTION!

Carefully handle the glass, especially around the edges of the front panel. The glass can break.

- Make sure the appliance is cold.
- Fully open the door.
- Press the clamping levers **A** on the two door hinges.

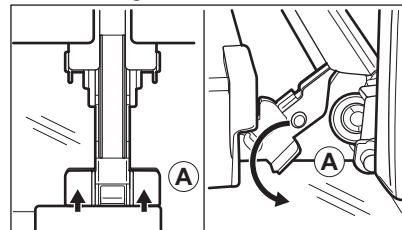

- Close the oven door to the first opening position (at approximate angle: 70°).
- Hold the door with one hand on each side and pull it away from the oven at an upwards angle.
- Put the door with the outer side down on a soft cloth on a stable surface.
- Hold the door trim **B** on the top edge of the door at the two sides and push inwards to release the clip seal.

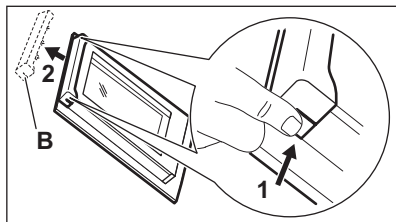

8. Pull the door trim to the front to remove it.
9. Hold the door glass panels on their top edge one by one and pull them up out of the guide.

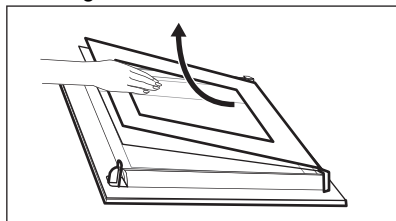

10. Clean the glass panel with water and soap. Dry the glass panel carefully. Do not clean the glass panels in the dishwasher.

After cleaning, do the above steps in the opposite sequence. Install the smaller panel first, then the larger and the door.

Make sure that the glass panels are inserted in the correct position otherwise the surface of the door may overheat.

## 11.12 Replacing the lamp

### **WARNING!**

Risk of electric shock.  
The lamp can be hot.

1. Turn off the appliance and wait until it is cold.
2. Disconnect the appliance from the mains.
3. Place the cloth on the oven floor.

### Top lamp

1. Turn the glass cover to remove it.

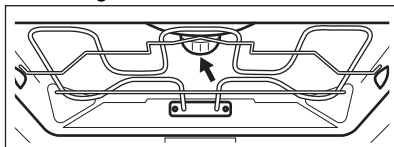

2. Remove the metal ring and clean the glass cover.
3. Replace the lamp with a suitable 300°C heat-resistant lamp.
4. Attach the metal ring to the glass cover and install it.

### Side lamp

1. Remove the left shelf support to get access to the lamp.
2. Use a Torx 20 screwdriver to remove the cover.
3. Clean the glass cover.
4. Replace the lamp with a suitable 300°C heat-resistant lamp.
5. Install the metal frame and the seal. Tighten the screws.
6. Install the left shelf support.

## 12. TROUBLESHOOTING

### **WARNING!**

Refer to Safety chapters.

## 12.1 What to do if...

Problem description	Cause and remedy
You cannot activate or operate the appliance.	The appliance is not connected to an electrical supply or it is connected incorrectly.
The appliance does not heat up.	The clock is not set. To set the clock refer to Clock functions.
	The door is not closed correctly.
	The fuse is blown. Make sure the fuse is the cause of the problem. If the problem recurs, contact a qualified electrician.
	Child Lock is activated.
The lamp is turned off.	The lamp is burnt out. Replace the lamp. For details refer to Care and cleaning.
The appliance does not retain the water tank after you insert it.	You did not fully press the water tank body. Fully insert the water tank into the appliance.
Water comes out of the water tank.	You did not assemble the lid of the water tank correctly.
The water tank is difficult to clean.	Make sure that the lid is removed before you start cleaning.
There is no water inside the tray after descaling.	The water tank was not filled in to the maximum level. Check if a descaling agent / water is present in the water tank body.
There is dirty water on the bottom of the cavity after descaling.	The tray is on a wrong shelf position. Remove the remaining water and the descaling agent from the bottom of the appliance. Next time put the tray on the first shelf position.
There is too much water on the bottom of the cavity after cleaning.	You put too much detergent in the appliance before you started cleaning. Next time evenly spread the thin layer of a detergent on the cavity walls.
Cleaning performance is not satisfactory.	You started cleaning when the appliance was too hot. Wait for the appliance to cool down. Repeat cleaning.
	You did not remove all the accessories from the appliance before cleaning. Remove all the accessories and repeat cleaning.
 Power cut always stops cleaning. Repeat cleaning if it's interrupted by power failure.	
Trouble with wireless network signal.	Check if your mobile device is connected to the wireless network. Check your wireless network and router. Restart the router.
New router installed or router configuration changed.	To configure appliance and mobile device again, refer to Before first use, Wireless connection.
The wireless network signal is weak.	Move router as close to the appliance as possible.
The wireless signal is disrupted by microwave oven placed near the appliance.	Turn off the microwave oven. Avoid using microwave oven and the Remote operation of the appliance at the same time. Microwaves disrupt WiFi signal.

## 12.2 Error codes

When the software error occurs, the display shows error message. You will find the list of problems in the table below.

Code and description	Remedy
<b>F102</b> - the door is not fully closed or the door lock is broken. <b>1)</b>	Close the door. Turn the appliance off and on.
<b>F111</b> - Food Sensor is not correctly inserted into the socket.	Fully plug Food Sensor into the socket.
<b>F240, F239</b> - the touch fields on the display do not work properly.	Clean the surface of the display. Make sure there is no dirt on the touch fields.
<b>F908</b> - the appliance system cannot connect with the control panel.	Turn the appliance off and on.
<b>F131</b> - the temperature of the steamer sensor is too high. <b>1) 2)</b>	Turn the appliance off and wait until it cools down. Turn the appliance on again.
<b>F144</b> - the sensor in the Water tank cannot measure the water level. <b>1) 2)</b>	Empty the Water tank and refill it.
<b>F508</b> - the Water tank does not work properly. <b>1) 2)</b>	Turn the appliance off and on.
<b>F602, F603</b> - Wi-Fi is not available. <b>1) 2)</b>	Turn the appliance off and on.

**1)** When the following error message continues to appear on the display, it means a faulty subsystem may have been disabled. In such a case contact your dealer or an Authorized Service Centre.

**2)** If one of these errors occurs, the rest of the appliance functions will continue to work as usual.

### 12.3 Service data

If you cannot find a solution to the problem yourself, contact your dealer or an Authorised Service Centre.

The necessary data for the service centre is on the rating plate. The rating plate is located on the front frame of the appliance. It is visible when you open the door. Do not remove the rating plate from the appliance.

**We recommend that you write the data here:**

Model (MOD.):

Product number (PNC):

Serial number (S.N.):

## 13. ENERGY EFFICIENCY

### 13.1 Energy saving tips

Following tips below will help you save energy when using your appliance.

Make sure that the appliance door is closed when the appliance operates. Do not open the appliance door too often during cooking. Keep the door gasket clean and make sure it is well fixed in its position.

Use metal cookware and dark, non-reflective tins and containers to improve energy saving.

Do not preheat the appliance before cooking unless specifically recommended.

Keep breaks between baking as short as possible when you prepare a few dishes at one time.

#### **Cooking with fan**

When possible, use the cooking functions with fan to save energy.

#### **Residual heat**

When the cooking duration is longer than 30 min, reduce the appliance temperature to minimum 3 - 10 min before the end of cooking. The residual heat inside the appliance will continue to cook.

Use the residual heat to keep the food warm or warm up other dishes.

When you turn off the appliance, the display shows the residual heat or temperature.

If a programme with Timer is activated and the cooking time is longer than 30 min, the heating elements automatically turn off earlier in some appliance functions.

#### **Keep food warm**

Choose the lowest possible temperature setting to use residual heat and keep the food warm. The residual heat indicator or temperature appears on the display.

#### **Cooking with the lamp off**

Turn off the lamp during cooking. Turn it on only when you need it.

#### **Heat Save Fan**

Function designed to save energy during cooking.

When you use this function the lamp automatically turns off after 30 sec. You may turn on the lamp again but this action will reduce the expected energy savings.

## 14. ENVIRONMENTAL CONCERNS

Recycle materials with the symbol . Put the packaging in relevant containers to recycle it. Help protect the environment and human health by recycling waste of electrical and electronic appliances. Do not dispose of

appliances marked with the symbol  with the household waste. Return the product to your local recycling facility or contact your municipal office.





