

ESF6010BW

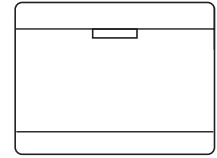

.....

EN Compact Dishwasher

.....

User manual

TH เครื่องล้างจานแบบตั้งโต๊ะ

คู่มือการใช้งาน



Electrolux

CONTENTS

1. Quick operation guide.....	2
2. Safety information.....	3
3. Operation instruction.....	6
4. Prior using for the first time.....	7
5. Loading the dishwasher basket.....	11
6. Starting a washing programme.....	12
7. Maintenance and cleaning.....	16
8. Installation instruction.....	18
9. Troubleshooting tips.....	22
10. Technical information.....	24
11. Consumer care center.....	25

Note:



- Please carefully read this manual before using the dishwasher, it will help you to use and maintain the dishwasher properly.
- Pass it on to any subsequent owner of the appliance.
- Keep it to refer to it at a later date.
- This manual contains sections on safety Instructions, Operating Instructions, Installation Instructions and Troubleshooting Tips, etc.

Before calling for service:

- To review the section on troubleshooting Tips will help you to solve some common problems by yourself.
- If you can not solve the problems by yourself, please ask for the help of professional technicians.

QUICK OPERATION GUIDE

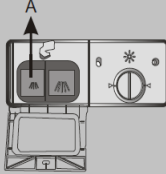
For detailed operating method read the corresponding content on the instruction manual.

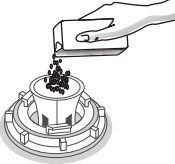
Switch on the appliance	Press the Power switch button to switch on the appliance, Open the door.
Fill the detergent dispenser	<p>Compartment A: With each wash cycle. (Follow the user instructions!)</p>  
Check the rinse aid level	Mechanical indicator C. Electric indicator on control panel (if provided).
Check the regeneration salt level	<p>(On models with water softener system only.) Electric indicator on control panel. Fill the salt into the softener by the number of cycles the dishwasher has run.</p> 
Load the baskets	Scrape off any large amount of leftover food. Soften remnants of burnt food in pans, then load the baskets. Refer to the dishwasher loading instructions.
Select a programme	Close the door, Press the programme button until the selected programme lights up. (See the section entitled "Operation instruction")
Running the dishwasher	Turn on the water tap and press the Start/Reset button. The machine will start working after about 10 seconds.
<ul style="list-style-type: none"> Changing the programme Add forgotten dishes in the dishwasher. If the appliance is switched off during a wash cycle. 	<ul style="list-style-type: none"> 1. A running cycle can only be modified if it has been running for a short time. Otherwise the detergent may have already been released and the water already drained. If this is the case, the detergent dispenser must be refilled. 2. Press the Start/Reset button more than 3 seconds to cancel the running programme. 3. Select a new programme. 4. Restart the dishwasher. <hr/> <ul style="list-style-type: none"> 1. Press the start/Reset button to stop the machine. 2. Open the door. 3. Add the forgotten dishes. 4. Close the door, then press the Start/Reset button, the dishwasher will start running again after 10 seconds. <hr/> <ul style="list-style-type: none"> If the appliance is switched off during a wash cycle, when switched on again, please re-select the washing cycle and operate the dishwasher according to the original Power-on state). <div style="border: 1px dashed black; padding: 5px; margin-top: 10px;"> <p>⚠ WARNING! Open the door carefully. Hot steam may escape when the door is opened!</p> </div>
Switch off the appliance	When the working cycle has finished, the buzzer of the dishwasher will sound 8 times, then stop. Turn off the appliance using the Power button. Since the appliance is standing by, it will power off automatically after 30 minutes without any operation.
Turn off the water tap, unload the baskets	Warning: wait a few minutes (about 15 minutes) before unloading the dishwasher to avoid handling the dishes and utensils while they are still hot and more susceptible to break. They will also dry better. Unload the appliance, starting from the lower basket.

SAFETY INFORMATION



WARNING! When using your dishwasher, follow the precautions listed below:

- This appliance is intended to be used in household and similar applications such as:
 - staff kitchen areas in shops, offices and other working environments;
 - farm houses;
 - by clients in hotels, motels and other residential type environments;
 - bed and breakfast type environments.
- This appliance can be used by children aged from 8 years and above and persons with reduced physical, sensory or mental capabilities or lack of experience and knowledge if they have been given supervision or instruction concerning use of the appliance in a safe way and understand the hazards involved. Children shall not play with the appliance. Cleaning and user maintenance shall not be made by children without supervision.
(For EN60335-1)
- This appliance is not intended for use by persons (including children) with reduced physical, sensory or mental capabilities, or lack of experience and knowledge, unless they have been given supervision or instruction concerning use of the appliance by a person responsible for their safety.
(For IEC60335-1)
- This appliance is for indoor use only, for household use only. To protect against the risk of electrical shock, do not immerse the unit, cord or plug in water or other liquid.
- Please unplug before cleaning and maintenance the appliance. Use a soft cloth moisten with mild soap, and then use a dry cloth to wipe it again.



EARTHING INSTRUCTIONS

- This appliance must be earthed. In the event of a malfunction or breakdown, earthing will reduce the risk of an electric shock by providing a path of least resistance of electric current. This appliance is equipped with a cord having an equipment-earthing conductor and a earthing plug.
- The plug must be plugged into an appropriate outlet that is installed and earthed in accordance with all local codes and ordinances.
- Improper connection of the equipment-earthing conductor can result in the risk of an electric shock. Check with a qualified electrician or service representative if you are in doubt whether the appliance is properly earthed.
- Do not modify the plug provided with the appliance; If it does not fit the outlet. Have a proper outlet installed by a qualified electrician.

- Do not abuse, sit on, or stand on the door or dish rack of the dishwasher.
- Do not operate your dishwasher unless all enclosure panels are properly in place.
- Open the door very carefully if the dishwasher is operating, there is a risk of water squirting out.
- Do not place any heavy objects on or stand on the door when it is open. The appliance could tip forward.
- When loading items to be washed:
 - 1) Locate sharp items so that they are not likely to damage the door seal;
 - 2) Warning: Knives and other utensils with sharp points must be loaded in the basket with their points down or placed in a horizontal position.
- Check that the detergent powder is empty after completion of the wash cycle.
- Do not wash plastic items unless they are marked dishwasher safe or the equivalent. For plastic items not so marked, check the manufacturer's recommendations.
- Use only detergent and rinse additives designed for an automatic dishwasher.
- Never use soap, laundry detergent, or hand washing detergent in your dishwasher.
- Children should be supervised to ensure that they do not play with the appliance.
- The door should not be left open, since this could increase the risk of tripping.
- If the supply cord is damaged, it must be replaced by the manufacturer or its service agent or a similarly qualified person in order to avoid a hazard.
- During installation, the power supply must not be excessively or dangerously bent or flattened.
- Do not tamper with controls.
- The appliance is to be connected to the water mains using new hose sets and that old hose-sets should not be reused.
- The maximum number of place settings to be washed is 8.
- The maximum permissible inlet water pressure is 1MPa.
- The minimum permissible inlet water pressure is 0.04MPa.

Disposal

Dispose of the dishwasher packaging material correctly.
All packaging materials can be recycled.

Plastic parts are marked with the standard international abbreviations:

- PE — for polyethylene, e.g. sheet wrapping material
- PS — for polystyrene, e.g. padding material
- POM — polyoxymethylene, e.g. plastic clips
- PP — polypropylene, e.g. Salt filler
- ABS — Acrylonitrile Butadiene Styrene, e.g. Control Panel .



WARNING!

- Packaging material could be dangerous for children!
- For disposing of package and the appliance please go to a recycling centre. Therefore cut off the power supply cable and make the door closing device unusable.
- Cardboard packaging is manufactured from recycled paper and should be disposed in the waste paper collection for recycling.
- By ensuring this product is disposed of correctly, you will help prevent potential negative consequences for the environment and human health, which could otherwise be caused by inappropriate waste handling of this product.
- For more detailed information about recycling of this product, please contact your local city office and your household waste disposal service.
- **DISPOSAL:** Do not dispose this product as unsorted municipal waste. Collection of such waste separately for special treatment is necessary.

OPERATION INSTRUCTION

! IMPORTANT To get the best performance from your dishwasher, read all operating instructions before using it for the first time.

Control Panel

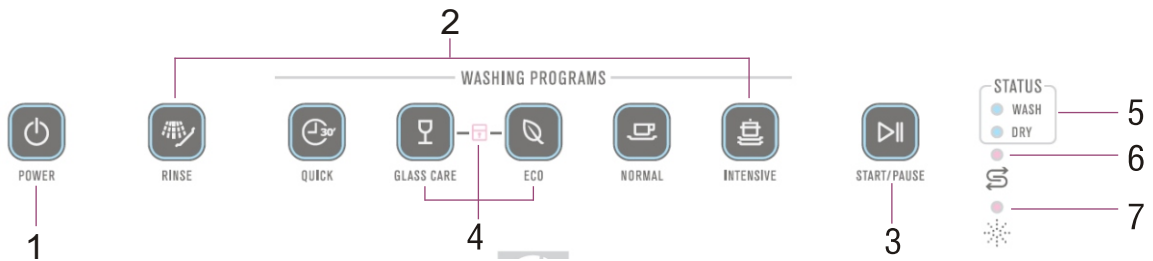

1---Power button and indicator: To switch On/Off the appliance, and the Power pilot lamp will be on when the power is on.

2---Washing Program Selector: Press a wash program button which you want to chose, and the washing program pilot lamp will be on.

3---Start/Pause Button: Press this button to start or pause the dishwasher, the process pilot lamp will be blinking when starting.

4---Child lock function: press Glass care button and ECO button simultaneously to lock the program, and the Child lock pilot lamp will be on.

5---Wash cycle indicator light: To show current state of wash cycle: Wash, Dry.

6---Salt warning light: To show when the salt container need to be refilled.

7---Rinse aid warning light: The light is on when the dispenser need to be refilled.

Dishwasher Features

Front view

Back View

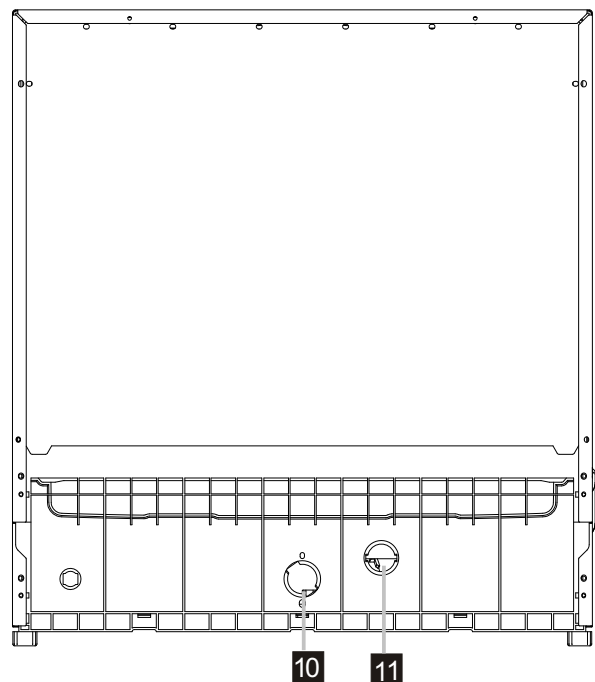
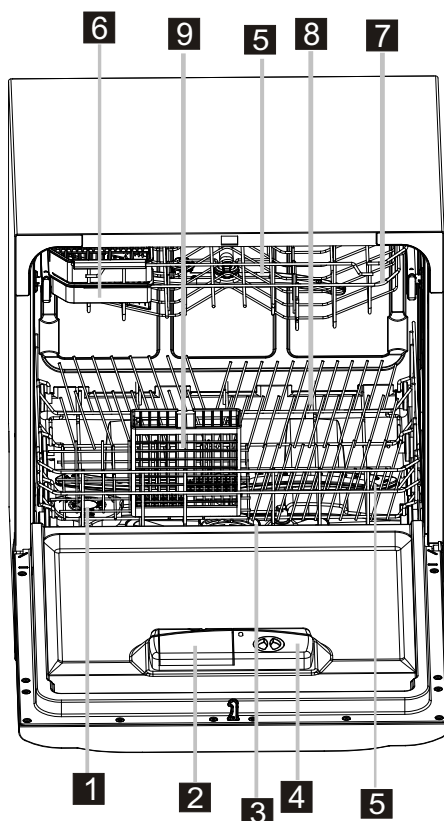

- | | | | | |
|------------------------------|------------------------------|--------------------------|-----------------------|--------------------------------|
| 1 Salt Container | 3 Filter assembly | 5 Spray Arms | 7 Upper basket | 9 Cutlery basket |
| 2 Detergent Dispenser | 4 Rinse Aid Dispenser | 6 Cutlery shelves | 8 Lower basket | 10 Inlet pipe connector |
| | | | | 11 Drain pipe connector |

PRIOR USING FOR THE FIRST TIME

! **NOTE:** If your model have no water softener, you may skip this section.

A. Loading the Salt Into the Salt container

Always use salt intended for use with dishwasher.

The salt container is located beneath the basket and should be filled as follows:

Attention!

- Only use salt specifically designed for use in dishwashers! All other types of salt not specifically designed for use in a dishwasher, especially table salt, will damage the water softener. In case of damages caused by the use of unsuitable salt the manufacturer does not give any warranty nor is liable for any caused damages.
- Only fill with salt just before starting one of the complete washing programmes. This will prevent any grains of salt or salty water, which may have been split, remaining of the bottom of the machine for any period of time, which may cause corrosion.

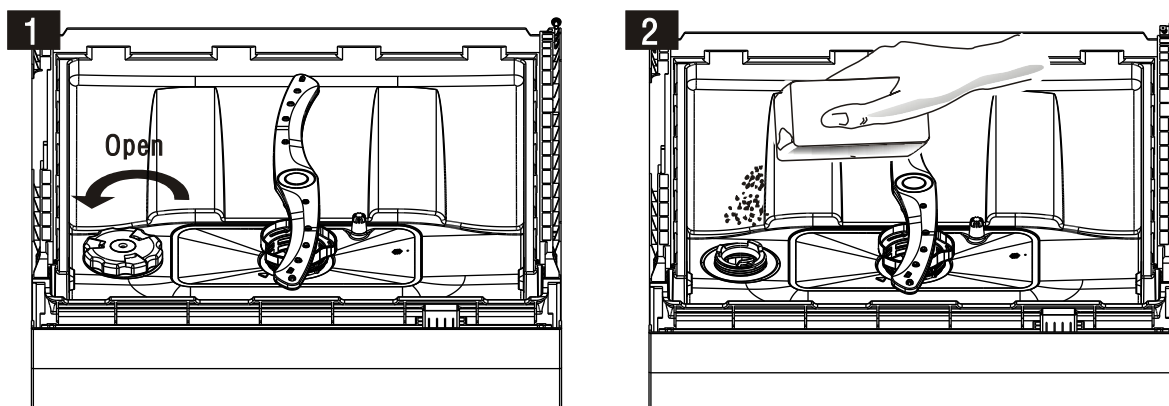

- A** Remove the basket and then unscrew and remove the cap from the salt container. (fig. **1**)
- B** Before first wash, add 1lt. of water in the salt container of your machine.
- C** Place the end of the funnel (supplied) into the hole and introduce about 1kg of salt. It is normal for a small amount of water to come out of the salt container. (fig. **2**)
- D** After filling the container, screw the cap tightly back clockwise.
- E** Usually, the salt warning light will cease to be illuminated within 2-6 days after the salt container has been filled with salt.
- F** Immediately after filling the salt into the salt container, a washing programme should be started (**Suggest choose Quick programme**). Otherwise filter system, pump or other important parts of the machine may be damaged by salty water. It is out of warranty.

! **NOTE:**

1. The salt container must only be refilled when the salt warning light in the control panel comes on. Depending on how fully the salt dissolves, the salt warning light may still be on even though the salt container is filled. If there is no salt warning light in the control panel (For some Models), you can judge when to load the salt into the softener by the cycles that the dishwasher had run.
2. If there are spills of the salt, a soak or a rapid program should be run to remove the excess salt.

Adjusting Salt Consumption

Step 1: Enter the status of salt adjustment

Close the door, within 60 seconds after power on, press Start/Pause button and hold for 5 seconds, the machine will enter setting mode.











Step 2: select a certain level of salt consumption

Press the Start/pause button to select the proper set according to your local environment, the sets will change in the following sequence: H1->H2->H3->H4->H5->H6;

Step 3: Exit the status of salt adjustment

Without any operation in five seconds, the machine will exit from set mode, the machine is into standby status

There are 6 levels of salt consumption in all. It is recommended to select the level according to below table:

Water Hardness level		Setting on the water softener	Digital display stalls
$^{\circ}\text{dH}^{1)}$	$\text{mmol/l}^{2)}$		
0-5	0-0.9	1	H1: INTENSIVE 
6-11	1.0-2.0	2	H2: NORMAL 
12-17	2.1-3.0	3	H3: INTENSIVE & NORMAL  
18-22	3.1-4.0	4*	H4: ECO 
23-34	4.1-6.1	5	H5: INTENSIVE & ECO  
35-45	6.2-8.0	6	H6: NORMAL & ECO  

Note:

1) German degree of measurement for the water hardness

2) millimol, international unit for water hardness

* factory setting

Contact your local water board for information on the hardness of your water supply.

B. Fill the Rinse Aid Dispenser

Rinse Aid Dispenser

The rinse aid is released during the final rinse to prevent water from forming droplets on your dishes. That can leave spots and streaks. It also improves drying by allowing water to sheet off the dishes. Your dishwasher is designed to use liquid rinse aids. The rinse aid dispenser is located inside the door next to the detergent dispenser. To fill the dispenser, open the cap and pour the rinse aid into the dispenser until the level indicator turns completely black. The volume of the rinse aid container is about 110ml.

Function of Rinse Aid

Rinse aid is automatically added during the last rinse, ensuring thorough rinsing, and spot and streak free drying.

Attention!

Only use branded rinse aid for dishwasher. Never fill the rinse aid dispenser with any other substances (e.g. Dishwasher cleaning agent, liquid detergent). This would damage the appliance.

When to Refill the Rinse Aid Dispenser

If there is no rinse-aid warning light in the control panel, you can judge the amount of rinse-aid by the color of the optical level indicator "C" located next to the cap. When the rinse-aid container is full, the whole indicator will be dark. As the rinse-aid diminishes, the size of the dark dot decreases. You should never let the rinse aid get below 1/4 full.

C (Rinse-Aid indicator)

As the rinse aid diminishes, the size of the black dot on the rinse aid level indicator changes, as illustrated below.

- Full
- ◐ 3/4 full
- ◑ 1/2 full
- ◒ 1/4 full - Should refill to eliminate spotting
- Empty

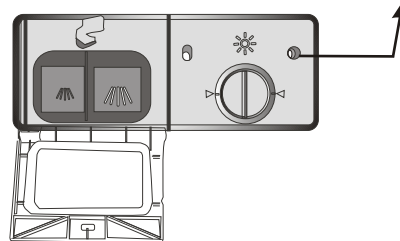

1



2

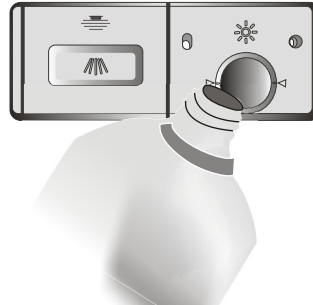

3



- 1 To open the dispenser, turn the cap to the "open" (left) arrow and lift it out.
- 2 Pour the rinse aid into the dispenser, being careful not to overfill.
- 3 Replace the cap by inserting it aligned with "open" arrow and turning it to the closed (right) arrow.

NOTE: Clean up any rinse aid spill during filling with an absorbent cloth to avoid excessive foaming during the next wash. Don't forget to replace the cap before you close dishwasher door.

Adjusting Rinse Aid Dispenser

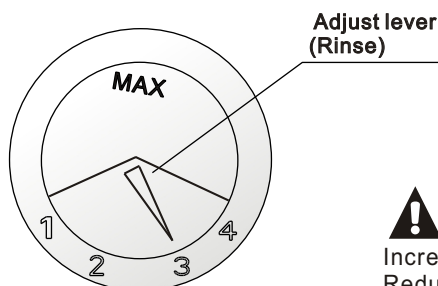

The rinse aid dispenser has four settings. The recommended setting is on "3". If the dishes still are not drying properly or are spotted, adjust the dial to the next higher number on "4".

NOTE:

Increase the dose if there are drops of water or lime spots on the dishes after washing. Reduce it if there are sticky whitish stains on your dishes or a bluish film on glassware or knife blades.

C. Function of Detergent

Detergents with its chemical ingredients are necessary to remove dirt, crush dirt and transport it out of the dishwasher. Most of commercial quality detergents are suitable for this purpose.

Normally new pulverised detergent is without phosphate. The water softener function of phosphate is not given. In this case we recommend to fill salt in the salt container even when the hardness of water is only 6 °dH. If detergents without phosphate were used in case of hard water often white spots appear at dishes and glasses. In this case please add more detergent to reach better results. Detergents without chlorine do only bleach a little. Strong and coloured spots will not be removed completely. In this case please choose a programme with higher Temperature.

Concentrated Detergent

Based on their chemical composition, dishwasher can be split in two basic types:

- conventional, alkaline detergents with caustic components
- low alkaline concentrated detergents with natural enzymes

Detergent Tablets

Detergent tablets of different brands dissolve at different speeds. For this reason some detergent tablets cannot dissolve and develop their full cleaning power during short programmes. Therefore please use long programmes when using detergent tablets, to ensure the complete removal of detergent residuals.

Detergent Dispenser

The dispenser must be refilled before the start of each wash cycle following the instructions provided in the Wash Cycle Table. Your dishwasher uses less detergent and rinse aid than conventional dishwasher. Generally, only one tablespoon of detergent is needed for a normal wash load. Also, more heavily soiled items need more detergent. Always add the detergent just before starting the dishwasher, otherwise it could get damp and will not dissolve properly.

Amount of Detergent to Use

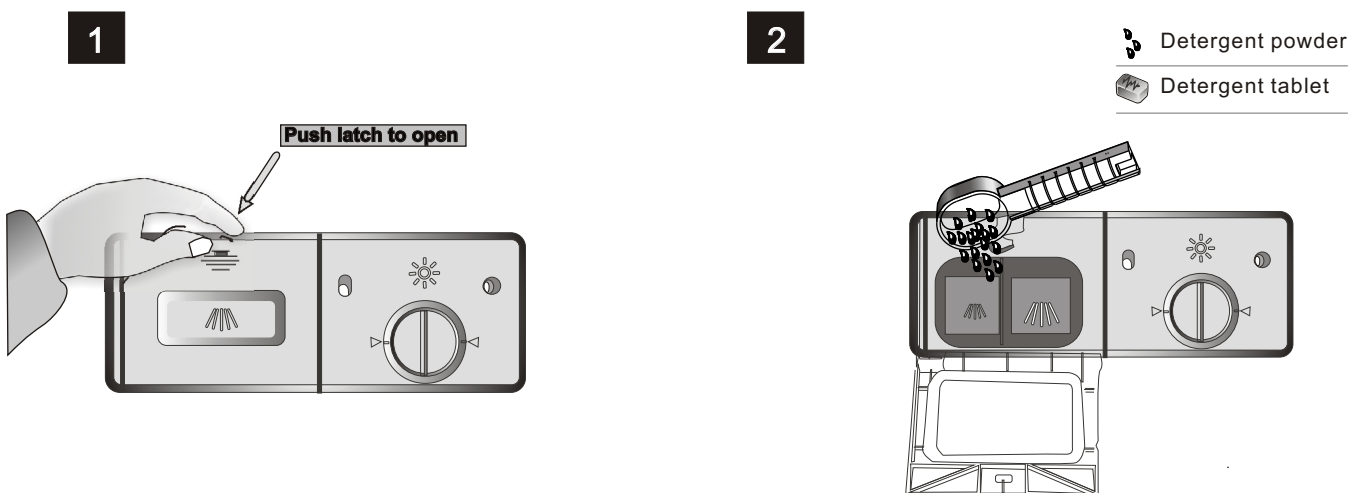

NOTE:

- If the lid is closed: press release button. The lid springs open.
- Always add the detergent just before starting each wash cycle.
- Only use branded detergent aid for dishwasher.



WARNING!

Dishwasher detergent is corrosive!
Take care to keep it out of reach of children.

Proper Use of Detergent

Use only detergent specifically made for use in dishwashers. Keep your detergent fresh and dry. Don't put powder detergent into the dispenser until you're ready to wash dishes.

Fill in detergent

Fill the detergent dispenser with detergent. The marking indicates the dosing levels, as illustrated on right:

A The place of main wash cycle detergent placed.

Please observe the manufacturer's dosing and storage Recommendations as stated on the detergent packaging.

Close the lid and press until it locks in place **B**.

If the dishes are heavily soiled, place an additional detergent dose in the detergent chamber.

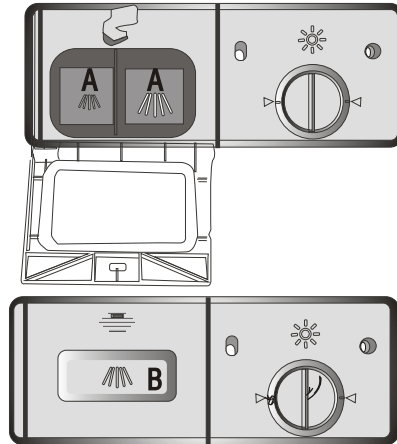

NOTE:

- You find information about the amount of detergent for the single programme on the last page.
- Please aware, that according to the level soiling and the specific hardness of water differences are possible.
- Please observe the manufacturer's recommendations on the detergent packaging.

5. Loading the Dishwasher Baskets

Recommendation

- Consider buying utensils which are identified as dishwasher-proof.
- Use a mild detergent that is described as 'kind of dishes'. If necessary, seek further information from detergent manufacturers.
- For particular items, select a programme with as low a temperature.
- To prevent damage, do not take glass and cutlery out of the dishwasher immediately after the programme has ended.

For washing in the dishwasher the following cutlery/dishes

Are not suitable

- Cutlery with wooden, horn china or mother-of-pearl handles
- Plastic items that are not heat resistant
- Older cutlery with glued parts that is not temperature resistant
- Bonded cutlery items or dishes
- Pewter or copper items
- crystal glass
- Steel items subject to rusting
- Wooden platters
- Items made from synthetic fibres

Are of limited suitability

- Some types of glasses can become dull after a large number of washes
- Silver and aluminium parts have a tendency to discolour during washing
- Glazed patterns may fade if machine washed frequently

STARTING A WASHING PROGRAMME

Attention before or after loading the Dishwasher Baskets

(For best performance of the dishwasher, follow these loading guidelines.
Features and appearance of baskets and cutlery baskets may vary from your model.)

Scrape off any large amounts of leftover food. Soften remnants of burnt food in pans
It is not necessary to rinse the dishes under running water.

Place objects in the dishwasher in following way:

1. Items such as cups, glasses, pots/pans, etc. are face down.
2. Curved items, or those with recesses, should be loaded at a slant so that water can run off.
3. All utensils are stacked securely and can not tip over.
4. All utensils are placed in the way that the spray arms can rotated freely during washing.



NOTE: Very small items should not be washed in the dishwasher as they could easily fall out of the basket.

- Load hollow items such as cups, glasses, pans etc. With the opening downwards so that water cannot collect in the container or a deep base.
- Dishes and items of cutlery must not lie inside one another, or cover each other.
- To avoid damage to glasses, they must not touch.
- Load large items which are most difficult to clean into the basket.
- Long bladed knives stored in an upright position are a potential hazard!
- Long and/or sharp items of cutlery such as carving knives must be positioned horizontally in the basket.
- Please do not overload your dishwasher. This is important for good results and for reasonable energy consume.

Loading the baskets according to En50242:

1. Upper basket:

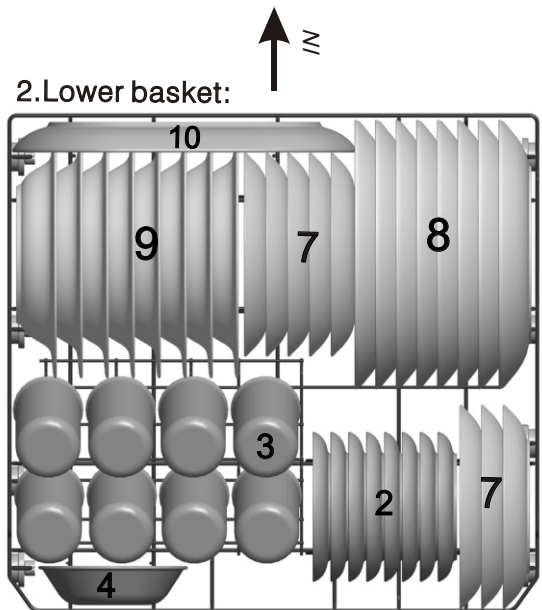
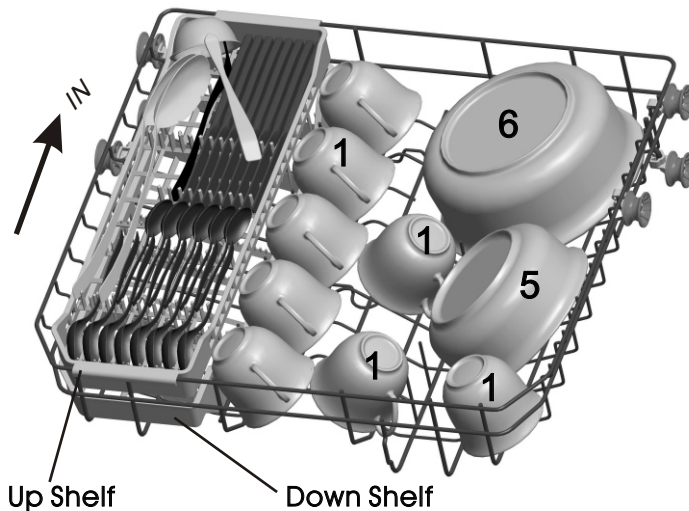

Saucers



Glasses



Small serving bowl



Medium serving bowl



Large serving bowl



Dessert dishes



Dinner plates





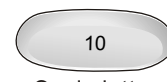



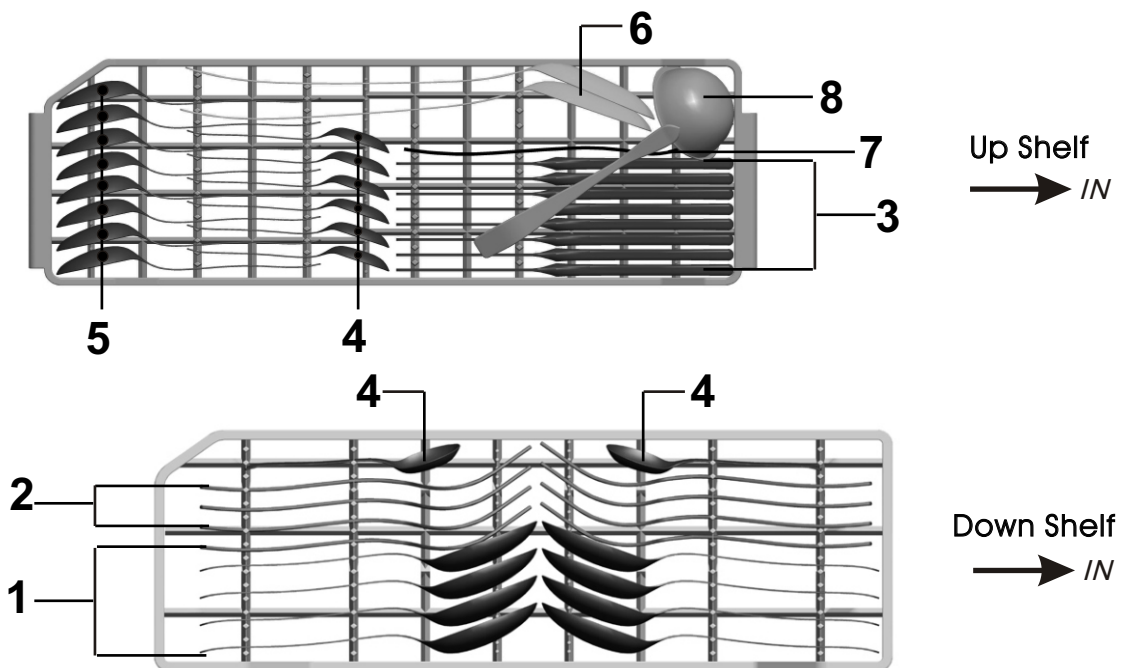

Soup plates



Oval platter

Note: Please place the light flat wares on the up shelf. The total weight is less than 2kg.



1	Soup spoons		5	Dessert spoons	
2	Forks		6	Serving spoons	
3	Knives		7	Serving forks	
4	Teaspoons		8	Gravy ladles	

Information for comparability tests in accordance with EN 50242

Capacity: 8 place settings

Programme: ECO

Rinse aid setting: 6

Softener setting: H4









▲ WARNING!

- Do not let any item extend through bottom.
- Always load sharp utensils with the sharp point down!

For personal safety and a top quality clean, place the silverware in the basket:

- They do not nest together.
- Place silverware with handles-down.
- But place knives and other potentially dangerous utensils handles-up.

Wash Cycle Table

Program	Cycle Selection Information	Description of Cycle	Detergent main	Running time(min)	Energy (Kwh)	Water (l)	Rinse Aid
 INTENSIVE	For heaviest soiled crockery, and normally soiled pots, pans, dishes etc with dried on soiling.	Pre-wash(45°C) Wash (65 °C) Rinse Rinse Rinse (70 °C) Drying	20g	160	1.35	13	★
 NORMAL	For normally soiled loads, such as pots, plates, glasses and lightly soiled pans.	Pre-wash(45 °C) Wash (60 °C) Rinse Rinse Rinse (65 °C) Drying	20g	150	1.25	13	★
 ECO (*EN5 0242)	This is standard programme, it is suitable to clean normally soiled tableware and it is the most efficient programme in terms of its combined energy and water consumption for that type of tableware.	Pre-wash Wash (45 °C) Rinse (65 °C) Drying	20g	185	0.82	8	★
 GLASS CARE	For lightly soiled crockery and glass.	Pre-wash Wash(45 °C) Rinse(65 °C) Drying	20g	100	0.7	10.5	★
 QUICK	A shorter wash for lightly soiled loads that do not need drying.	Wash (35 °C) Rinse Rinse (40 °C)	18 g	30	0.35	7	
 RINSE	Use for rinsing dishes and glasses that will not be wash right away.	Pre-wash	---	13	0.01	3	

! NOTE:

*EN 50242 : This programme is the test cycle. The information for comparability test in accordance with EN 50242, as follows:

- Capacity: 8 setting
- Rinse aid setting: 6
- The power consumption of off-mode is 0.45W
left-on mode is 0.49W

Turning On the Appliance

Starting a wash cycle...

Draw out the basket(see the section entitled “Loading the Dishwasher”).

Pour in the detergent (see the section entitled “Salt, Detergent and RinseAid”).

Insert the plug into the socket. The power supply is 220-240 VAC

50 HZ, the specification of the socket is 10 A250 VAC.

Make sure that the watersupply is turned on to full pressure.

! NOTE:

When you press the Start/Reset button to pause during washing, the program light will stop blinking and the dishwasher will mooring every minute unless you press the Start/Reset button to start.

Change the Programme...

Premise: You can modify the washing program when the dishwasher just runs for a short time. Otherwise, the detergent may have already been released, and the appliance may have already drained the wash water. If this is the case, the detergent dispenser must be refilled (see the section entitled "Loading the Detergent").

Press Start/Reset Button more than three seconds the machine will be in stand by state, then you can change the program to the desired cycle setting (see the section entitled "Starting a wash cycle...").

NOTE: If you open the door during the washing cycle, the machine will pause. When you close the door and press the start/reset button, the machine will keep on working after 10 seconds.

The program lights show the state of the dishwasher:

- a) One of the program lights on-----stand by or pause
- b) One of the program lights blinking----- run



NOTE: *If you open the door when washing, the machine will pause. When you close the door, the machine will keep on working after 10 seconds.*

Forget to Add a Dish?

A forgotten dish can be added any time before the detergent cup opens.

- 1** Press the start/reset button
- 2** Open the door a little to stop the washing.
- 3** After the spray arms stop working, you can open the door completely.
- 4** Add forgotten dishes.
- 5** Close the door
- 6** Press the start/reset button, the dishwasher will run after 10 seconds.

At the end of the Wash Cycle

When the working cycle has finished, the buzzer of dishwasher will sound 8 seconds, then stop. Turn off the appliance using the Power button, shut off the water supply and open the door of the dishwasher. Wait a few minutes before unloading the dishwasher to avoid handling the dishes and utensils while they are still hot and more susceptible to breakage. They will also dry better.

■ Switch Off the Dishwasher

1. Switch off the dishwasher by pressing the Power button.
2. Turn off the water tap!

■ Open the door carefully.

Hot dishes are sensitive to knocks. The dishes should therefore be allowed to cool down around 15 minutes before removing from the appliance.

Open the dishwasher's door, leave it ajar and wait a few minutes before removing the dishes. In this way they will be cooler and the drying will be improved.

■ Unloading the dishwasher

It is normal that the dishwasher is wet inside.



WARNING!

It is dangerous to open the door when washing, because the hot water may scald you.

MAINTENANCE AND CLEANING

Filtering System

The filter prevent larger remnants of food or other objects from getting inside the pump.

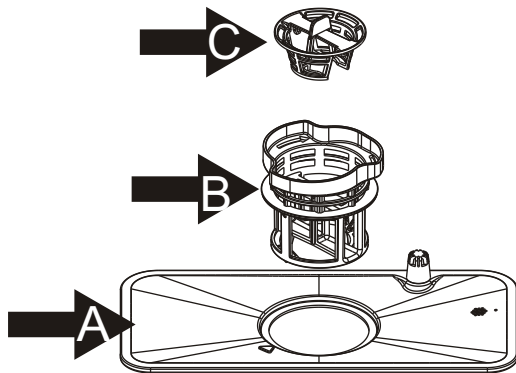

The filter system consists of a coarse filter, a flat (Main filter) and a micro filter (fine filter).

Main filter **A**

Food and soil particles trapped by this filter are pulverized by a special jet on the spray arm and washed down to drain.

Fine filter **B**

This filter holds soil and food residue in the sump area and prevents it from being deposited on the dishes during wash cycle.

Coarse filter **C**

Larger items, such as pieces of bone or glass, that could block the drain are trapped in the coarse filter. To remove the items caught by the filter, gently squeeze the tap on the top of this filter and lift out.

Filter assembly

The filter efficiently removes food particles from the wash water, allowing it to be re-cyclated during the cycle. For best performance and results, the filter assembly must be regularly. For this reason, it is a good idea to remove the larger food particles trapping in the filter after each wash cycle by rinsing the filter and cup under running water. To remove the filter assembly, pull on the cup handle in the upward direction.

⚠ WARNING!

Never run the dishwasher without the filters in place. The dishwasher must never be used without the filters. Improper replacement of the filter may reduce the performance level of the appliance and damage dishes and utensils.

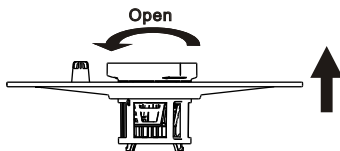

Step1: contrarotate the filter assembly(A,B and C), then lift it all up.

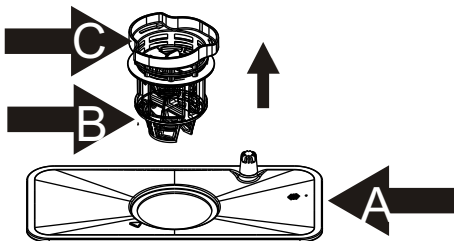

Step2: lift B and C up from A;

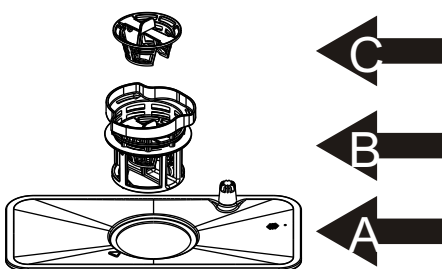

The End.

⚠ NOTE: *If do it from step1 to step 3, the filter system will be removed; while if do it from Step 3 to Step 1, the filter system will be installed.*

Remarks:

- Inspect the filters for blocking every time the dishwasher has been used.
- By unscrewing the coarse filter, you can remove the filter system. Remove any food remnants and clean the filters under running water.

⚠ NOTE: The entire filter assembly should be cleaned once a week.

Cleaning The Filter

To clean the coarse filter and the fine filter, use a cleaning brush. Reassemble the filter parts as shown in the figures in the last page and reinsert the entire assembly in the dishwasher, positioning in its seat and pressing downward.

⚠ WARNING!

When cleaning the filters, don't knock on them. Otherwise, the filters could be contorted and the performance of dishwasher could be debased.

Caring for the Dishwasher

The control panel can be cleaned by using a lightly dampened cloth and dry thoroughly.

The exterior use a good appliance polish wax.

Never use sharp objects, scouring pads or harsh cleaners on any part of the dishwasher.

Cleaning The Door

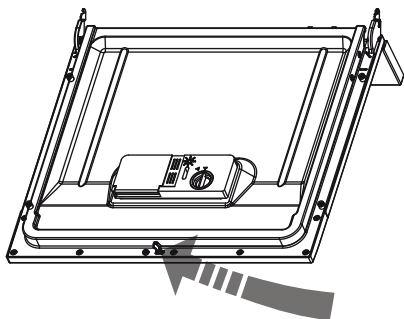

To clean the edge around the door, you should use only a soft warm, damp cloth. To avoid penetration of water into the door lock and electrical components, do not use a spray cleaner of any kind.

⚠ WARNING!

Never use a spray cleaner to clean the door panel as it may damage the door lock and electrical components. Abrasive agent or some paper towel should not be used because of the risk of scratching or leaving spots on the stainless steel surface.

Cleaning the Spray Arms

It is necessary to clean the spray arms regularly as hard water chemicals will clog the spray arm jets and bearings.

To remove the upper spray arm, hold the nut, rotate the arm clockwise to remove it.

To remove the lower spray arm, pull out the spray arm upward.

Wash the arms in soapy and warm water and use a soft brush to clean the jets. Replace them after rinsing them thoroughly.

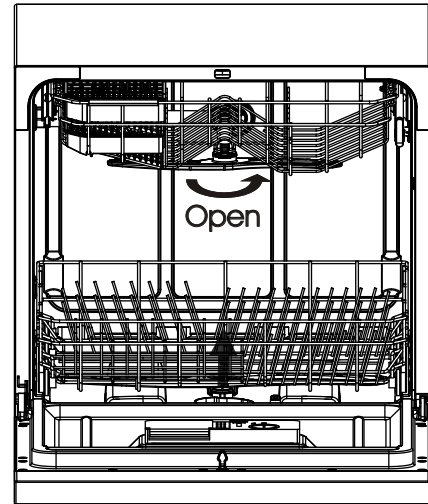

How to Keep Your Dishwasher in Shape

■ After Every Wash

After every wash, turn off the water supply to the appliance and leave the door slightly open so that moisture and odors are not trapped inside.

■ Remove the Plug

Before cleaning or performing maintenance, always remove the plug from the socket.

■ No Solvents or Abrasive Cleaning

To clean the exterior and rubber parts of the dishwasher, do not use solvents or abrasive cleaning products. Only use a cloth with warm soapy water. To remove spots or stains from the surface of the interior, use a cloth dampened with water with a little vinegar, or a cleaning product made specifically for dishwashers.

■ When it is not in need for a long time

It is recommended that you run a wash cycle with the dishwasher empty and then remove the plug from the socket, turn off the water supply and leave the door of the appliance slightly open. This will help the door seals to last longer and prevent odors from forming within the appliance.

■ Moving the Appliance

If the appliance must be moved, try to keep it in the vertical position. If absolutely necessary, it can be positioned on its back.

■ Seals

One of the factors that cause odors to form in the dishwasher is food that remains trapped in the seals. Periodic cleaning with a damp sponge will prevent this from occurring.

INSTALLATION INSTRUCTION

Attention:

The installation of the pipes and electrical equipments should be done by professionals.

Warning

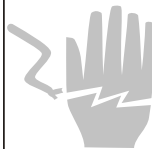

Electrical Shock Hazard
Disconnect electrical power before installing dishwasher.

Failure to do so can result in death or electrical shock.

Installation preparation

The installation position of dishwasher should be near the existing inlet and drain hoses and power cord.

One side of the cabinet sink should be chosen to facilitate the connection of drain hoses of the dishwasher.

Positioning the Appliance

Position the appliance in the desired location. The back should rest against the wall behind it, and the sides, along the adjacent cabinets or wall. The dishwasher is equipped with water supply and drain hoses that can be positioned to the right or the left to facilitate proper installation.

About Power Connection

! WARNING!

For personal safety:

- Do not use an extension cord or an adapter plug with this appliance.
- Do not, under any circumstances, cut or remove the earthing connection from the power cord.

Electrical Requirements

Please look at the rating label to know the rating voltage and connect the dishwasher to the appropriate power supply. Use the required fuse 10 amp, time delay fuse or circuit breaker recommended and provide separate circuit serving only this appliance.

Electrical Connection

! *Insure proper ground exists before use*

Ensure the voltage and frequency of the power being corresponds to those on the rating plate. Only insert the plug into an electrical socket which is earthed properly. If the electrical socket to which the appliance must be connected is not appropriate for the plug, replace the socket, rather than using a adaptors or the like as they could cause overheating and burns.

Water Connection

Cold Water Connection

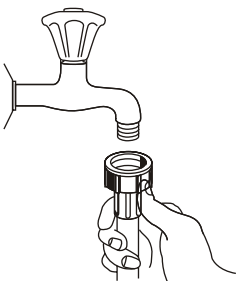

Connect the cold water supply hose to a threaded 3/4(inch) connector and make sure that it is fastened tightly in place. If the water pipes are new or have not been used for an extended period of time, let the water run to make sure that the water is clear and free of impurities. If this precaution is not taken, there is a risk that the water inlet can get blocked and damage the appliance.

! **WARNING!** please close the hydrant after using.

Connection of drain hoses

Insert the drain hose into a drain pipe with a minimum diameter of 4cm, or let it run into the sink, making sure to avoid bending or crimping it. Use the special plastic support that comes with the appliance. The free end of the hose must be at a height lower than 75cm and must not be immersed in water to avoid the back flow of it.



Attention:

The special plastic hose support must be solidly fastened to the wall to prevent the drain hose from moving and allowing water to spill outside the drain.

PLEASE HANG UP THE DRAIN HOSE EITHER WAY OF A, B

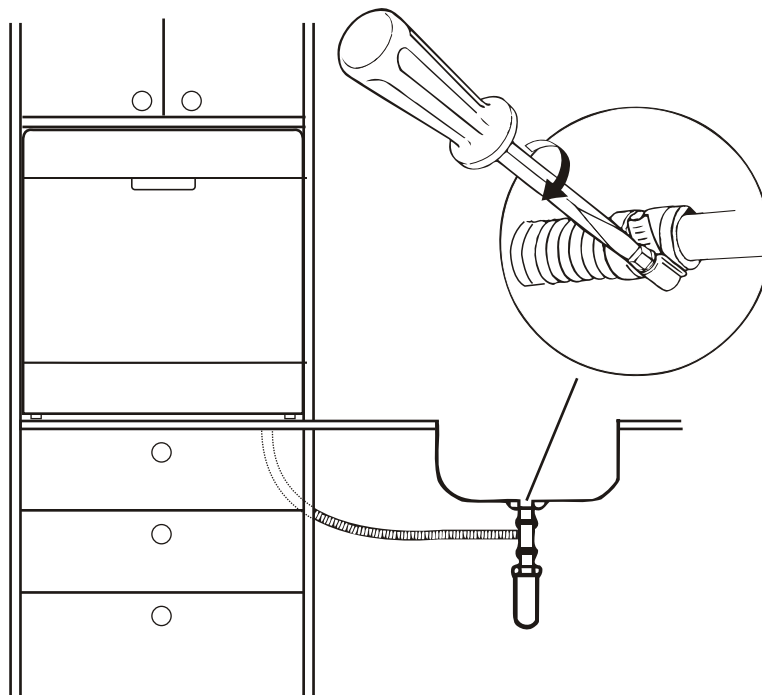
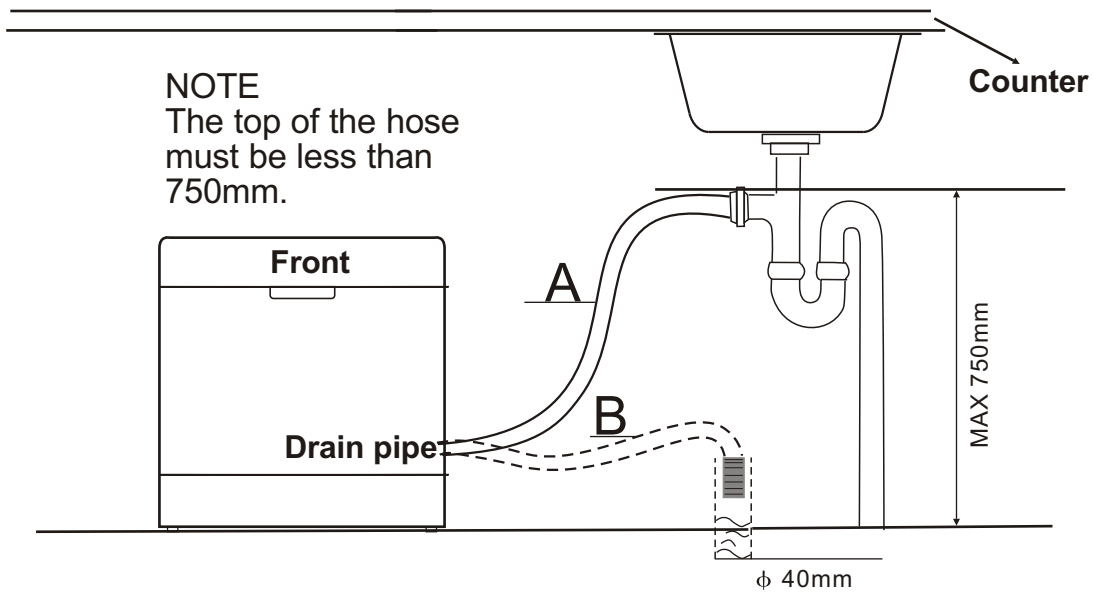

How to Drain Excess Water From Hoses

If the sink is 1000mm higher from the floor, the excess water in hoses cannot be drained directly into the sink. It will be necessary to drain excess water from hoses into a bowl or suitable container that is held outside and lower than the sink.

Water Outlet

Connect the water drain hose. The drain hose must be correctly fitted to avoid water leakage. Ensure that the water drain hose is not kinked or squashed.

Extension Hose

If you need a drain hose extension, observe to use a similar drain hose. It must be no longer than 4 metres; otherwise the cleaning effect of the dishwasher could be reduced.

Start of dishwasher

The following things should be checked before starting the dishwasher.

- 1 The dishwasher is level and fixed properly
- 2 The inlet valve is open
- 3 Inlet hose connections are fully tightened and not leaking
- 4 The wires are tightly connected
- 5 The power is switched on
- 6 The inlet and drain hoses are knotted
- 7 All packing materials and printings should be taken out from the dishwasher



Attention: *After installation, please make sure to keep this manual.*

The content of this manual is very helpful to the users.

TROUBLESHOOTING TIPS

Before Calling for Service

Review the charts on the following pages may save you from calling for service.



	<i>Problem</i>	<i>Possible Causes</i>	<i>What To Do</i>
	<i>Dishwasher doesn't start</i>	Fuse blown, or the circuit breaker tripped.	Replace fuse or reset circuit breaker. Remove any other appliances sharing the same circuit with the dishwasher
		Power supply is not turned on.	Make sure the dishwasher is turned on and the door is closed securely. Make sure the power cord is properly plugged into the wall socket.
	Technical problems	Door of dishwasher not properly closed.	Closed dishwasher making sure that door latches.
		<i>Water not pumped from dishwasher</i>	Kink in drain hose
Filter clogged.	Check the coarse filter. (see section titled "Cleaning The Filter ")		
Kitchen sink clogged.	Check kitchen sink to make sure it is draining well. If problem is kitchen sink not draining ,you may need a plumber rather than a serviceman for dishwasher.		
General problems	<i>Suds in the tub</i>	Improper detergent	Use only the special dishwasher detergent to avoid suds. If this occurs, open the dishwasher and let suds evaporate. Add 1 gallon of cold water to the tub. Close and latch the dishwasher, then Start any wash cycle to drain out the water . Repeat if necessary.
		Spilled rinse-aid	Always wipe up rinse-aid spills immediately.
	<i>Stained tub interior</i>	Detergent with colourant was used.	Make sure that the detergent is the one without colourant.
	<i>White film on inside surface</i>	Hard water minerals	To clean the interior, use a damp sponge with dishwasher detergent and wear rubber gloves. Never use any other cleaner than dishwasher detergent for the risk of foaming or suds.
	<i>There are rust stains on cutlery</i>	The affected items are not corrosion resistant.	
A programme was not run after dishwasher salt was added. Traces of salt have got into the wash cycle.		Always run the Quick wash programme . without any crockery in the dishwasher and without selecting the Turbo function (if present), after adding dishwasher salt.	
The lid of softer is loose.		Check the lip .Ensure the fix is fine.	
Noise	<i>Knocking noise in the wash cabinet</i>	The spray arm is knocking against an item in a basket.	Interrupt the programme, and rearrange the items which are obstructing the spray arm.
	<i>Rattling noise in the wash cabinet</i>	Item of crockery are insecure in the wash cabinet.	Interrupt the programme, and rearrange the items of crockery.
	<i>Knocking noise in the water pipes</i>	This may be caused by on-site installation or the cross-section of the piping.	This has no influence on dishwasher function. if in doubt, contact a suitably qualified plumber.



Unsatis-
-factory
washing
result

<i>Problem</i>	<i>Possible Causes</i>	<i>What To Do</i>
<i>The dishes are not clean</i>	The dishes were not loaded correctly.	See notes in " Loading the Dishwasher Baskets ".
	The programme was not powerful enough.	Select a more intensive programme. See" Wash Cycle Table ".
	Not enough detergent was dispensed.	Use more detergent, or change your detergent.
	Item are blocking the path of spray arms.	Rearrange the items so that the spray can rotate freely.
	The filter combination in the base of wash cabinet is not clean or is not correctly fitted. This may cause the spray arm jets to get blocked.	Clean and/or fit the filter combination correctly. Clean the spray arm jets. See "Cleaning the Spray Arms".
<i>Cloudiness on glassware</i>	Combination of soft water and too much detergent.	Use less detergent if you have soft water and select a shortest cycle to wash the glassware and to get them clean.
<i>Black or gray marks on dishes</i>	Aluminum utensils have rubbed against dishes.	Use a mild abrasive cleaner to eliminate those marks.
<i>Detergent left in dispenser cups</i>	Dishes block detergent cups.	Re-loading the dishes properly.

Unsatis-
-factory
drying
result

<i>The dishes are not drying</i>	Improper loading	Load the dishwasher as suggested in the directions.
	Too little rinse-aid	Increase the amount of rinse-aid/Refill the rinse-aid dispenser.
	Dishes are removed too soon.	Do not empty your dishwasher immediately after washing. Open the door slightly so that the steam can escape. Begin unloading the dishwasher only once t he dishes are barely warm to the touch. Empty the low basket first. This prevents water form dropping off dishes in the upper basket.
	Wrong programme selection	In short programmes the washing temperature is lower. This also lowers cleaning performance. Choose a programme with a long washing time.
	Using cutlery with a low-quality coating	Water drainage is more difficult with these items. Cutlery or dishes of this type are not suitable for washing in the dishwasher.

Error Codes

When some malfunctions come on, the appliance will display error codes to warn you:

<i>Codes</i>	<i>Meanings</i>	<i>Possible Causes</i>
<i>The PANELAS light flicker fleetly</i>	Longer inlet time.	Faucets is not opened, or water intake is restricted, or water pressure is too low.
<i>The ECO light flicker fleetly</i>	Overflow.	Some element of dishwasher leaks .

⚠ WARNING!

If overflow occurs, turn off the main water supply before calling a service. If there is water in the base pan because of an overfill or small leak, the water should be removed before restarting the dishwasher.

TECHNICAL INFORMATION

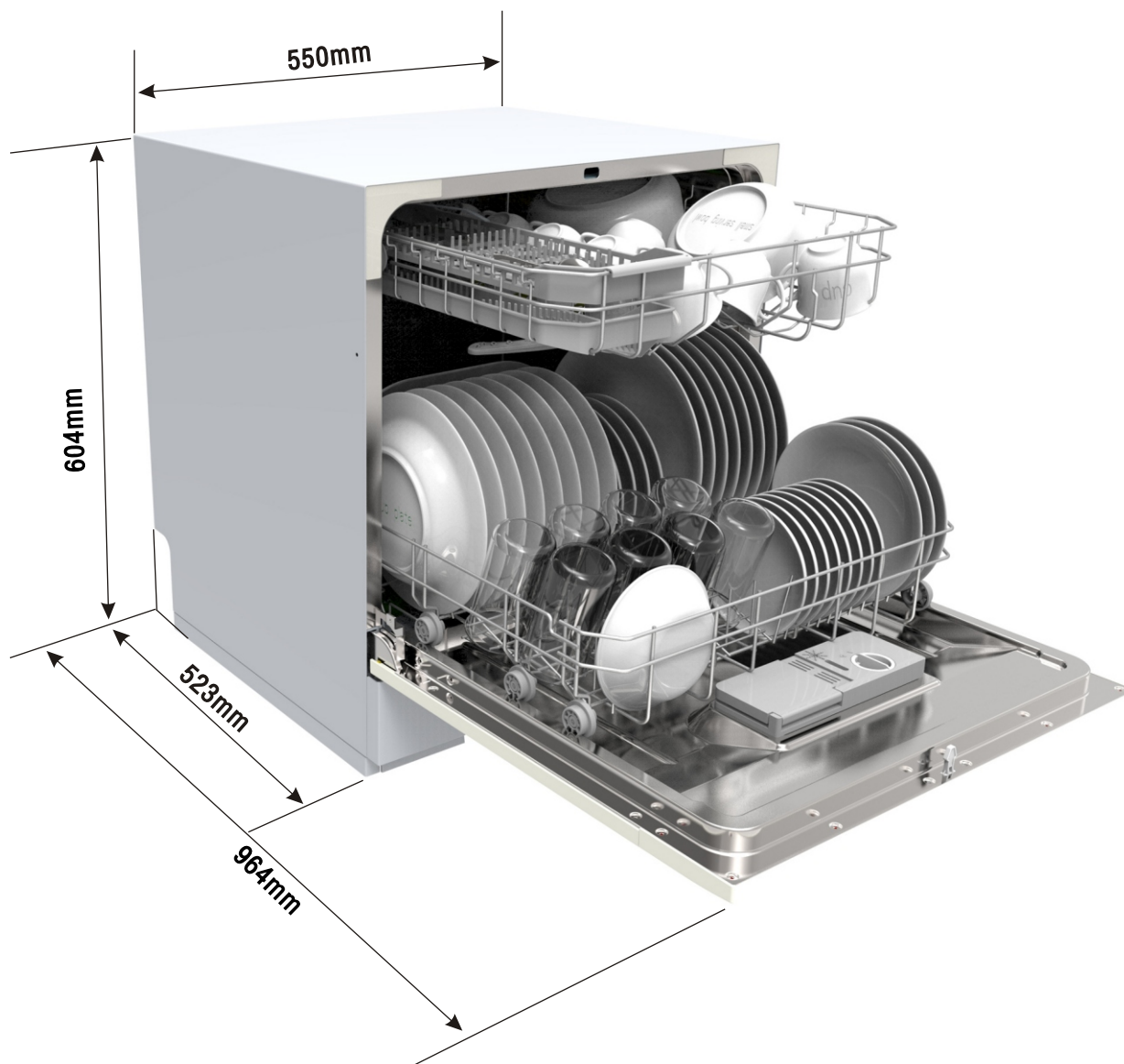

Model: ESF6010BW

Height :	604mm
Width :	550mm
Depth :	523mm
Voltage connected Load :	see rating label
Water pressure:	0.04–1.0MPa
Power supply:	see rating label
Capacity:	8 Place settings

RoHS
Compliant.

Environmental Information

If at any time in future you need to dispose of this product please do NOT dispose of this product with household waste. Please send this product to collecting points where available.

This product is RoHS compliant.

CONSUMER CARE CENTER

<p>Indonesia Consumer Care Center Tel : (+62 21) 522 7180 PT. Electrolux Indonesia Gedung Plaza Kuningan Menara Utara 2nd Floor, Suite 201, Jl. HR Rasuna Said kav C 11-14, Karet Setiabudi Jakarta Selatan 12940 Office Tel: (+62 21) 522 7099 Office Fax: (+62 21) 522 7097 Email : customercare@electrolux.co.id</p>	<p>Singapore Consumer Care Center Tel: (+65) 6727 3699 Electrolux S.E.A. Pte Ltd. 1 Fusionopolis Place, #07-10 Galaxis, West Lobby Singapore 138522. Office Fax : (+65) 6727 3611 Email : customer-care.sin@electrolux.com</p>
<p>Malaysia Consumer Care Center Tel: 1300-88-11-22 Electrolux Home Appliances Sdn. Bhd. Corporate Office Address: Unit T2-7, 7th Floor, Tower 2 , Jaya33 Hyperoffice, No. 3, Jalan Semangat, Seksyen 13, 46100 Petaling Jaya, Selangor Office Tel : (+60 3) 7843 5999 Office Fax : (+60 3) 7955 5511 Consumer Care Center Address: Lot C6, No. 28, Jalan 15/22, Taman Perindustrian Tiong Nam, 40200 Shah Alam, Selangor Consumer Care Center Fax : (+60 3) 5524 2521 Email : malaysia.customercare@electrolux.com</p>	<p>Thailand Consumer Care Tel : (+66 2) 725 9000 Electrolux Thailand Co., Ltd. Electrolux Building 14th Floor 1910 New Phetchaburi Road, Bangkapi, Huai Khwang, Bangkok 10310 Office Tel : (+66 2) 7259100 Office Fax : (+66 2) 7259299 Email : customercarethai@electrolux.com</p>
<p>Philippines Consumer Care Center Toll Free : 1-800-10-845-CARE 2273 Consumer Care Hotline : (+63 2) 845 CARE 2273 Electrolux Philippines, Inc. 10th Floor. W5th Avenue Building 5th Avenue Corner 32nd Street Bonifacio Global City, Taguig Philippines 1634 Trunkline: +63 2 737- 4756 Website : www.electrolux.com.ph Email : wecare@electrolux.com</p>	<p>Vietnam Consumer Care Center Toll Free : 1800-58-88-99 Tel : (+84 8) 3910 5465 Electrolux Vietnam Ltd. Floor 9th, A&B Tower 76 Le Lai street - Ben Thanh Ward - District 1 Ho Chi Minh City , Vietnam Office Tel : (+84 8) 3910 5465 Office Fax : (+84 8) 3910 5470 Email : vncare@electrolux.com</p> <p>Hongkong Tel: (+852) 8203 0298 Dah Chong Hong, Ltd. - Service Centre 8/F., Yee Lim Godown Block C 2-28 Kwai Lok Street, Kwai Chung, N.T.</p>

www.electrolux.com

The Thoughtful Design Innovator.

Do you remember the last time you opened a gift that made you say, “Oh! How did you know? That’s exactly what I wanted!” That’s the kind of feeling that we at Electrolux seek to evoke in everyone who chooses or uses one of our products. We devote time, knowledge, and a great deal of thought to anticipating and creating the kind of appliances that our customers really need and want.

This kind of thoughtful care means innovating with insight. Not design for design’s sake, but design for the user’s sake. For us, thoughtful design means making appliances easier to use and tasks more enjoyable to perform, freeing our customers to experience the ultimate 21st century luxury: ease of mind. Our aim is to make this ease of mind more available to more people in more parts of their everyday lives, all over the world.

The “Thinking of you” promise from Electrolux goes beyond meeting the needs of today’s consumers. It also means we’re committed to making appliances safe for the environment—now and for future generations.

Electrolux. Thinking of you.

Share more of our thinking at
www.electrolux.com

